

DOCUMENT RESUME

ED 265 668

IR 051 408

AUTHOR McCombs, Gillian M.
TITLE Catalog Maintenance Online in ARL Libraries. SPEC Kit 119.
INSTITUTION Association of Research Libraries, Washington, D.C. Office of Management Studies.
PUB DATE Dec 85
NOTE 134p.
AVAILABLE FROM Systems and Procedures Exchange Center, Office of Management Studies, 1527 New Hampshire Avenue NW, Washington, DC 20036 (\$20.00).
PUB TYPE Collected Works - General (020) -- Guides - General (050) -- Reports - Research/Technical (143)

EDRS PRICE MF01 Plus Postage. PC Not Available from EDRS.
DESCRIPTORS *Academic Libraries; Administrative Organization; Databases; Higher Education; Library Administration; *Library Automation; *Library Catalogs; Library Planning; Library Surveys; *Library Technical Processes; Occupational Information; Online Systems; *Research Libraries; State Libraries

IDENTIFIERS Association of Research Libraries; *Online Catalogs

ABSTRACT

To gather information on current catalog maintenance practices, researchers selected institutions from respondents to the September 1984 version of the OMS (Office of Management Studies) Automation Inventory of Research Libraries. A telephone survey of technical services and systems staff at 23 libraries investigated a wide range of issues related to both the database itself and organization-staffing. A concise summary addresses: planning and system issues; staffing and organization issues; and trends and implications. The kit contains SPEC survey information (questions asked, libraries contacted, documents received); manuals for catalog maintenance procedures from 10 institutions (University of Illinois at Urbana-Champaign, Pennsylvania State University, Syracuse University, University of Virginia, Duke University, University of California at Los Angeles, Northwestern University, Virginia Polytechnic Institute and State University, the New York State Library, and University of New Mexico); job descriptions and/or organization charts from five institutions (Pennsylvania State University, Northwestern University, University of Maryland, Virginia Polytechnic Institute and State University, and University of New Mexico) and a selective bibliography. (THC)

 * Reproductions supplied by EDRS are the best that can be made *
 * from the original document. *



flyer

#119
NOV.-DEC. 1985

OMS

Systems and Procedures Exchange Center

ISSN 0160 3582

CATALOG MAINTENANCE ONLINE IN ARL LIBRARIES

Libraries always have performed some level of catalog maintenance, usually in card format, from simply filing cards and later withdrawing them as holdings were removed, through maintaining a full syndetic structure that includes making cross-references and changing forms of entry as cataloging rules change. While an online environment offers increased access points, more flexible searching, and the ability to make global changes, new maintenance procedures need to be developed to take advantage of these capabilities. In the current climate of transition, efforts to clean up and match records in automated systems often are hampered by the realities of installed systems which differ from those planned for, the need to maintain dual catalogs, incomplete documentation for revised procedures, and fluctuating job responsibilities.

To gather information on current catalog maintenance practices, researchers selected institutions from respondents to the September 1984 version of the *OMS Automation Inventory of Research Libraries*. The institutions represented all sizes of ARL libraries and several stages of automation, from preliminary planning to moving toward fully integrated online status. A telephone survey of technical services and systems staff investigated a wide range of issues related to both the database itself and organization-staffing. Listings of interview questions and institutions contacted can be found in the Kit. Twenty-three libraries participated in phone interviews, and 14 submitted documents.

PLANNING AND SYSTEM ISSUES. The amount of online maintenance activity underway in the surveyed libraries depended mainly on whether they had completed maintenance resulting from the initial building of the database. Half of the libraries were still doing this maintenance, plus maintenance resulting from subsequent retrospective conversions. The level of bibliographic control (i.e., the ability to manipulate the data) libraries reported they had achieved also varied, depending on both how the current automated database was built—e.g., all records keyed in, OCLC tapes loaded, or retrospective conversion—and on cataloging and maintenance practices previous to automation. Another factor was the current stage of system implementation. For example, a library that was recovering from a "loader" program having stripped out all periods

and spaces from call numbers—thereby precluding any matching—was less likely to report it had bibliographic control than a library which had had two years to debug its system.

The ease or difficulty of catalog maintenance usually depends on both the demands of the automated system and on the policies and priorities of the organization during planning and implementation. Survey respondents uniformly noted that maintenance is easier when requirements are determined as specifications are developed. Catalog maintenance functions will be quite different, for example, in a library that decides to bring up an online catalog without authority control, with the intention of adding it later. Whereas authority control does ensure easier maintenance, it is a high-expense function, requiring additional staffing and upfront expenditures.

A number of libraries reported unexpected catalog maintenance problems when the system acquired was different from what had been requested in the original proposal. In four libraries, RFP's were sent out initially for circulation systems, whereas the system finally installed was an integrated package where the cataloging system formed the basis for an online catalog and circulation system. Catalog maintenance support needed from the vendor, therefore, had not been specified in enough detail.

The amount of lead time for catalog maintenance when bringing up a system also was identified as a crucial factor. If the database is "dirty"—which can result from conflicting cataloging practices or the use of an old batch circulation system as a database—maintenance staff will want time to clean it up or upgrade it, in order to avoid more complicated problems during subsequent routine maintenance or maintenance associated with retrospective conversion and loading of authority tapes. However, it can be difficult to find the time and resources to clean up and match records when a library is in the middle of bringing up a system and at the same time continuing to circulate books.

Not surprisingly, three-quarters of the survey respondents stated that their maintenance efforts required more resources than originally planned, from terminals to technical support staff. They reported being hampered by a lack of up-to-date, complete documentation for turnkey systems, as compared

with information from cataloging utilities. Though turnkey vendors are marketing increasingly sophisticated integrated packages, their manuals and support materials tend to be behind current releases. To help fill this gap, librarians have formed user groups, and are contacting other sites with similar systems for answers to problems.

STAFFING AND ORGANIZATION ISSUES.

Reorganization of personnel often is discussed in connection with automated systems. In this survey, nine out of 23 libraries reported they had carried out major organizational or workflow changes, some crossing division lines. As maintenance units which cross traditional department lines are created, the level of staffing changes. Many clerical staff become data entry operators, while library technical assistants or other levels of professional staff assume responsibility for the manipulation of bibliographic records. Kit #112 (March 1985) discusses the reorganization of technical and public services due to automation in more detail.

The issue of where to place responsibility for catalog maintenance was particularly difficult for libraries with several subsystems. For example, a number of libraries were attempting to determine responsibility for updating a circulation system using information from the cataloging system in technical services—especially pertinent when the circulation system was used as an online public access catalog. In some cases, the size of the institution helped determine maintenance responsibilities. Smaller institutions with fewer branch libraries could keep control within cataloging with technical services doing all the updating. Larger institutions often trained circulation staff in some procedures, and developed ways for other units to assist with maintenance.

The role of the systems office varied from institution to institution, depending mainly on whether the system was inhouse or turnkey. In the former case, there was heavy involvement, while in the latter case, systems personnel were concerned mainly with keeping the system operational, relying upon technical services to do the maintenance and putting pressure on vendors to reprogram the system.

While system configurations and library size place major demands on how and where maintenance is performed, an organization's policies and philosophy regarding access to and control of bibliographic data also can influence how it plans for and reorganizes catalog maintenance functions. As systems become more integrated, the catalog maintenance unit in technical services can play a pivotal role, becoming the basis of a library-wide database maintenance unit which crosses the boundaries of traditional circulation, technical, and reference services divisions.

TRENDS AND IMPLICATIONS. Most online integrated systems are not installed with the expectation of reducing costs initially, yet there is considerable interest in whether automation will actually result in increased productivity or reduced processing time. While few institutions have been able to document savings in maintenance, the new online systems do allow libraries to maintain more control over bibliographic data and holdings than with earlier manual card systems.

There will certainly be many more generations of improvements and interfaces affecting catalog maintenance, yet experiences so far do have implications for future planning. First, even though catalog maintenance procedures and responsibilities are driven to a great extent by the nature of the automated system(s) and library size, an organization can still plan and reorganize to reflect its philosophy regarding control of and access to information, and can take into account the needs and concerns of public and technical services units. Second, the amount of investment in catalog maintenance during implementation must be weighed against other needs -- including keeping the system itself functioning. Administrators need to determine the extent of maintenance required during transitions to assure continued user access to records, at the same time planning for more extensive clean-up and upgrades in later phases. Third, management and staff involved in maintenance activities must be good planners, yet flexible and creative in their responses to the inevitable changes within automated systems. And fourth, the installation of automated systems without consideration of concurrent, substantial reorganization of staff will limit potential gains in productivity or improvement in services.

The SPEC Kit on Catalog Maintenance Online in ARL Libraries (#119, November-December 1985, 122 pages) contains SPEC survey information (questions asked, libraries contacted, documents received), 10 examples of catalog maintenance procedures, job descriptions and organization charts from five institutions, and a selected bibliography.

This Kit was prepared by Gillian M. McCombs, Head, Catalog, Authority Files, and Shelflist Maintenance Department, University Libraries, State University of New York at Albany.

SPEC Kits (ISSN 0160 3582) are available by subscription through subscription services or direct from the publisher. Individual issues cost \$20.00, plus \$5.00 postage outside the U.S., through distributors or direct. (ARL member price \$10.00.) Prepayment is required. If ordering direct, send check payable to "ARL Office of Management Studies" to: SPEC, Office of Management Studies, 1527 New Hampshire Ave., Washington, D.C. 20036. Order by Kit Number and Title. Direct Order Forms listing back issues and Subscription Forms are available the same address.

USES OF SPEC KITS

The Systems and Procedures Exchange Center (SPEC) is a clearinghouse operated by the Association of Research Libraries, Office of Management Studies that provides a central source of timely information and materials on the management and operations of large academic and research libraries. It facilitates the exchange of knowledge and documents through SPEC Kits, which are distributed ten times each year to ARL members and other interested libraries. The Kits include topically-arranged groupings of unedited primary source documents - selected for their value to administrators and decision-makers - that illustrate a wide range of alternative approaches to specific issues.

Kit documents come from general membership surveys and from selected libraries contacted directly by SPEC, and most Kits are produced within six months of surveys. The documents' value comes from their variety of ideas, methods, and solutions. They are not viewed as finished products, but rather as points of departure for a library's planning efforts and as stimulants to innovative approaches to problem-solving. As such, Kits do not present answers or prescriptions for any one library; instead they illustrate how selected ARL members are planning for or dealing with particular issues. The worth of any one Kit to a particular library will depend upon the specific topic covered and the library's stage of development in that area.

Materials are selected according to the following criteria:

- Presents an approach of potential value to administrators and decision-makers
- Timely, and dealing directly with the topic under consideration
- Probability of application of ideas or thinking to other library situations
- Illustrative of actual practice, rather than theoretical
- Understandable, readable communication

All together, the materials should provide a range of alternative approaches that complement each other, provide variety, and stimulate comparison and contrast.

Libraries can take advantage of the Kit compilations in a number of ways. Administrators can evaluate the assumptions, methods, and results of other libraries' approaches; compare and contrast them; and use the learnings in their own situations. Library staff members can use the kits as professional development and current awareness tools. Committees and task forces can use them to begin a review of current practices. And the Kits can identify other persons or places to contact for further information. Back-up files in the SPEC office also are available for loan to member libraries. In addition, SPEC will conduct on-demand surveys or analyses geared specifically for a single library.

EVALUATION

Kit Title/Number _____

1. Which uses did the library make of this Kit?

2. Please indicate how useful the Kit was for these purposes.

Very Useful Quite Useful Somewhat Useful Not Useful

3. Do you have suggestions for this Kit or for future Kits?

(optional) NAME _____

LIBRARY _____

PHONE _____

Please return this form to the SPEC Center, OMS/ARL, 1527 New Hampshire Ave., N.W., Washington, DC 20036.

SPEC SURVEY Telephone Survey Questions, List of Institutions Contacted, List of Documentation Received	1
 CATALOG MAINTENANCE PROCEDURES	
<u>Online Catalogue Maintenance: The University of Illinois at Urbana-Champaign. 1984.</u>	6
<u>OOPS Report Procedure and Sample Page of OOPS Report Generated. Pennsylvania State University. 1985.</u>	23
<u>SULIRS Error Report Form, Authority Work Overview, SULIRS Clean-up Specifications. Syracuse University. 1984.</u>	34
<u>Database Maintenance and Security (selected portion of Planning Committee report on system requirements). University of Virginia. 1984.</u>	43
<u>Letter Outlining Evolution Toward Online Catalog Maintenance. Duke University. 1985.</u>	45
<u>Letter Listing Documents, introduction to the ORION Browse Command, ORION Templates. University of California, Los Angeles. 1983, 1985.</u>	48
<u>Letter with Responses to Telephone Interview, Minimum Input Standards for NOIS Authority Records, Corrections to Existing Cataloging: Major vs. Minor, A Proposal to Weed the main Author-Title Card Catalog of Computer- Produced and Non-NUL Cards. Northwestern University. 1980-1985.</u>	64
<u>VTLS Authority Control: Goals and Objectives. Virginia Polytechnic Institute and State University.</u>	82
<u>Flow Charts on Collection Management System and Bibliographic Data, Collection Management System Overview. New York State University. 1982.</u>	83
<u>Letter, Linking Item Records for Titles Bound Together (Dataphase Procedure #2), Quality Control Policy for Dataphase Database. University of New Mexico. 1985.</u>	86
 ORGANIZATION CHARTS AND JOB DESCRIPTIONS	
<u>Bibliographic Resources and Services Division Organization Chart. Pennsylvania State University. 1985.</u>	98
<u>Technical Services Organization Charts. Northwestern University. 1982-1985.</u>	99
<u>Job Descriptions. University of Maryland. 1985.</u>	103
<u>Job Descriptions. Virginia Polytechnic Institute and State University. 1984.</u>	108
<u>Organization Chart, Job Descriptions. University of New Mexico. 1982-1985.</u>	112
SELECTIVE BIBLIOGRAPHY	122

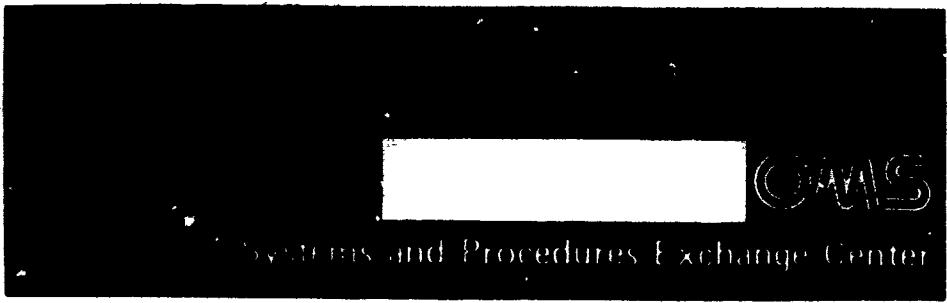
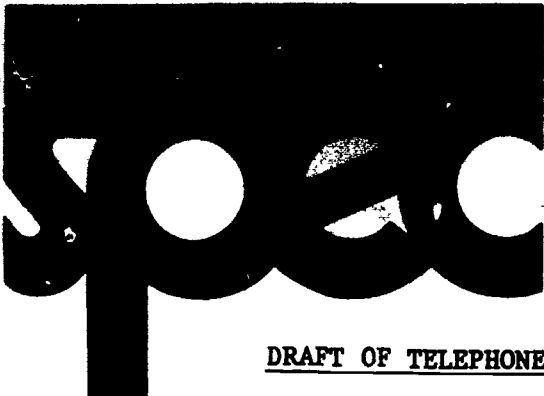

DRAFT OF TELEPHONE SURVEY QUESTIONS ON ON-LINE CATALOG MAINTENANCE

Questions are divided into two main sections - database and staffing.

I. Database

1. Was file maintenance covered in the original automation planning? Does that reflect what you have now i.e. did you plan correctly or not?
2. Do you have more or less bibliographic control over your database? Before, changes in the card catalog were only a question of how much labour one had to deploy. Now things happen that you have no control over, for instance periodic being stripped from call numbers, stop words being applied in the wrong places. Many problems result from programming errors and have to be manually corrected. It is one thing to spend a lot of time changing headings because of AACR2, but another to be rectifying errors in the system.
3. How much maintenance is a result of the original tapeloading (transfer, keying in etc.), or is anticipated routine daily (weekly, monthly) maintenance?
4. Whose responsibility is the database - CIRC, Technical Services? Any problems with this? Who is responsible for inputting or loading the info, correcting errors? (This is especially pertinent when a CIRC database is used as an Online Catalog.)
5. File security - any problems with unauthorized people getting into the system, not just students breaking the codes, but Reference Librarians correcting call numbers etc.?
6. How have procedures for online maintenance developed? Whose responsibility is it to develop them? Have vendors been helpful in supplying adequate documentation? Did libraries with no previous automation experience find it easy to change to using printouts for file maintenance? Describe your current maintenance procedures.
7. Does anyone feel they actually have an integrated system?
8. Has there been an increase or decrease in the ability to check errors, do authority work, revise catalogers' work etc.
9. Resources - were the planned resources enough? Were you able to follow through properly on the loading? Were enough terminals allocated for maintenance?

II. Staffing

1. Any major reorganization of Technical Services Staff or Library Staff as a whole? A decrease or increase in staff? Has a separate catalog maintenance unit been created, or did it exist already? Redistribution of job assignments? Redistribution of job descriptions?

II. Staffing Cont'd.

2. Has there been any labour or time-saving noticed, or anticipated after initial shakedown? Has anyone actually closed their card catalog, (how long after going on-line did they do it) or is everybody just maintaining two systems, and probably not doing full maintenance on either?
3. Staff training - done by whom? Any problems with getting 56 year old typists retrained as DEMOS? How much reclassification of jobs? Has the level of intricacy moved up or down - are LTA's now doing what was clerical work or vice versa? Are catalogers doing their own maintenance - who is in control?
4. Any provisions made for follow up on hazards of continuous VDT use e.g. annual eye exams? Any push from staff for this, or complaints? Are any precautions being taken, by use of special screens, glare preventives, scheduling only certain number of hours at a time or not allowing pregnant women to use them heavily?

I will be asking for documentation to include

online catalog maintenance manuals
terminal schedules
maintenance procedures
revised job descriptions
plans for changes in workloads
plans for reorganization of libraries, divisions, departments, etc.
policy changes

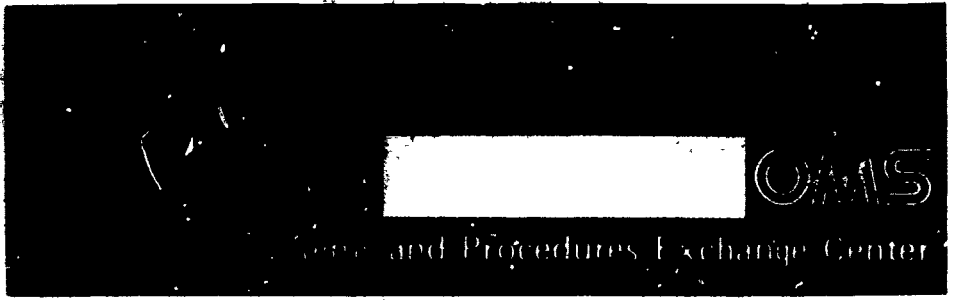

INSTITUTIONS CONTACTED

- Columbia University
- Cornell
- Duke University
- Howard University
- New York State Library
- New York University
- Northwestern University
- Pennsylvania State University
- Smithsonian Institution
- Syracuse University
- SUNY Albany
- SUNY Buffalo
- Virginia Poly Tech.
- University of Illinois
- University of Maryland
- University of New Mexico
- University of Tulane
- University of Virginia

DOCUMENTATION RECEIVED

1. Comparative profile of Integrated Online Systems : 2 cover letters : Jackson-George Regional Library, Pascagoula, Ms. (23p.)
2. Minimum input standards NOTIS authority records: creation of NOTIS authority file: Procedures for conversion of bib. records to NOTIS: Use of LMS and card catalogs problem reporting forms: Corrections to existing cataloging (major vs. minor errors): Corrections procedures for catalog management staff: Catalog Dept. corrections procedures: Catalog cards and cross-refs defiling: Proposal for computer-card weeding: card pulling project: Closing pre-AACR2 catalog: Cat. Dept. Responsibilities after day 1: Tech Services Orgn. chart: Paper on catalog maintenance: Memo on automation-related shifts in Tech. Services: Northwestern Un. Lib. Orgn. chart: other unit orgn. charts. cover letter: Northwestern University, Illinois. (62p.)
3. VTLS authority control, goals and objectives: conversion of holdings: job descriptions: VTLS error report: procedures for online authority control: cover letter: Virginia Polytechnic, Blacksburg, Va. (28p.)
4. GEAC terminal schedules: job descriptions: procedures manual: cover letter. University of Maryland. (31p.)
5. Keyboard description doc.: procedures for updating records on ORION: adding of records to ORION: introduction to Browse command: introduction to Serials Module: introduction to Acquisitions Module: Cover letter. University of California at Los Angeles. (49p.)
6. Online editing system recommendations: OES Corrections chart: TRLN exceptions report priority chart: TRLN Online Editing System uses information: TRLN Bibliographic Information System Technical User Manual: Cover letter. Duke University. (221p.)
7. SULIRS User's Guide: article on SULIRS: recataloging procedures: selective retrospective conversion procedures: SULIRS error report form SULIRS links explanation: authority work procedures: corrections procedures to OCLC diagnostics: SULIRS change specifications: SULIRS overview: cover letter. Syracuse University. (43p.)
8. GEAC record error report: Geac cataloging worksheet: MRMS procedures: Office Automation Survey for Government Employees: SUNY Albany. (20p.)

9. Online Catalog Planning Committee report on system requirements : Library Safety and Emergencies Committee memo. University of Virginia. (60p.)
10. Authority record worksheet: Maintenance order worksheet: ONLICATS Manual: BIPS manual. New York State Library. (80p.)
11. Online Catalogue Maintenance: The University of Illinois at Urbana Champaign. Includes overview, Corrections sheets, file maintenance change requests, correction tables, link file maintenance procedures, error/system matrix, linker file examples, organizational chart. University of Illinois at Urbana Champaign. (17p.)
12. Organization chart: OOPS report procedures: copy of OOPS report: Miscellaneous articles. Pennsylvania State University. (44pp.)
13. Documentation package from Joseph Busch, now at Price Waterhouse, formerly of NETSL.
14. Documentation package from Janet Frederick, University of New Mexico.

ONLINE CATALOGUE MAINTENANCE:
THE UNIVERSITY OF ILLINOIS AT URBANA-CHAMPAIGN

Sharon E. Clark

1. DATABASE

The library of the University of Illinois at Urbana-Champaign (UIUC) has had automation since the 1970's, having joined OCLC in 1974 and having implemented an automated online circulation system, LCS (Library Computer System), in 1978. The LCS programs which originated at the Ohio State University have been modified to accommodate local needs. LCS contains brief records for over 3 million titles held by the UIUC Library. Each LCS record includes main entry, title, call number, place and date of publication, edition statement, LC card number, and detailed holdings information by copy and location. Currently, LCS provides access to the collections of 27 academic institutions in Illinois as well as document delivery through the Illinois Library Delivery System (ILDS).

When an online catalogue was planned it was determined to integrate LCS into the system. While LCS was to serve as the master shelflist, the on-order file, and the only record of current location, a second component, the Full Bibliographic Record (FBR) was to provide the full records for the Online Catalogue system. Based on Washington Library Network (WLN) software, FBR contains full bibliographic records, with the exception of the call number, for monographs, serials, and audiovisual materials catalogued at the UIUC since the mid-seventies via OCLC. As part of a state library development grant, the FBR database also includes full records of the River Bend Library System (Illinois). Currently the database contains over 860,000 full MARC records of which over 800,000 are UIUC records. Formats not available in FBR at this time include: maps, manuscripts, music, sound recordings, and newspapers. In addition FBR does not include records for the following languages: Chinese, Japanese, Korean, Hebrew, Persian, and Armenian.

Authority control is provided for name, series, and subjects through the initial loading of the 1981 Library of Congress Name Authority tapes and tapes for the 9th edition of the Library of Congress Subject Headings. The authority files grow as new names, series, and subject headings are stripped from incoming records each week and loaded in the authority file. Over 2 million headings and cross-references are currently in the authority file.

A holdings file was established by using the duplicate processing specification of WLN, a feature of the software whereby all libraries holding a particular item can be displayed. This feature has proven particularly useful in differentiating between the UIUC Library and the River Bend Library System records when searching the Online Catalogue. The utility of this file will obviously increase as more LCS libraries adopt the Online Catalogue.

Access to both systems, LCS and FBR, from the same terminal is provided through a "link" which allows a patron to move from the Full Bibliographic Record to its corresponding LCS record for call number, location, and circulation information. It is these two separate systems linked together that form the UIUC Library's Online Catalogue. The Online Catalogue, which became operational in September, 1984, is currently available on over 200 terminals at the UIUC. The system runs on an IBM mainframe.

II. MAINTENANCE

In the planning and implementation of the Online Catalogue, maintenance was extremely important. Initially, the FBR database was to include cataloguing records created through OCLC since November, 1979 when the Library adopted AACR2 as its official cataloguing code. At that time the old main card catalogue was closed and a "New Books" AACR2 catalogue was initiated. However, the Library owned OCLC archival tapes from 1974-1979, which, if edited to AACR2 form could be loaded into the Full Bibliographic Record file of the Online Catalogue database. Therefore, the UIUC Library contracted with the Amigos Bibliographic Council, Inc. to accomplish the AACR2 conversion of bibliographic records created through OCLC for materials catalogued since 1974. The AACR2 conversion process performed by Amigos allowed for increasing the initial size of the database as well as significantly reducing the amount of subsequent manual maintenance, which otherwise would have been required.

Another aspect of the service provided by Amigos was the elimination of duplicate records, a necessary requirement prior to locally developed software being able to establish links between the FBR records and its counterpart in LCS. As OCLC records are loaded into the Online Catalogue database each week, (LCS and FBR), the automatic links for the same item are created through matching the call number in LCS with the 09X field in the MARC record. The 09X field is then removed from the FBR record. It is this effective linking capability which supported the Library's decision to continue to store call number and holdings information in LCS only, thereby eliminating the need to perform maintenance on this information in both LCS and FBR files. After materials are catalogued through OCLC and the OCLC archival tapes are

generated, the tapes are then loaded into LCS and FBR. Once the tapeloading is complete, the link between the records is created by the University programmers.

Subsequent catalogue maintenance of LCS, FBR, and the link is handled in the Automated Records Maintenance Section (ARM) of the Automated Systems Department at the UIUC Library (Appendices A-C). Changes to LCS may be made online utilizing the workfile to modify location and circulation period. The majority of changes to LCS, however, are batched using SUPERWYLBUR, a modified text editor, and its datafiles: UPDATES and HOLDING. UPDATES corresponds to the LCS master file record and is used for changes involving bibliographic and copy information. The HOLDING file is used for changes to monographic series and serial holdings and corresponds to the Serial Holding Record in LCS. LCS and link maintenance is run weekly. As a manual quality control a temporary shelflist file is maintained in Automated Systems. All updated records are filed weekly by call number. After the OCLC tapes are loaded into the Online Catalogue each week, the records are checked against LCS and FBR for accuracy and to ensure that the link has been made. Printouts are made for any records containing errors and routed for correction. Reports are generated weekly denoting statistics on number of records successfully added as well as those rejected.

A limitation to SUPERWYLBUR is that the inputter is unable to view the LCS record when keying in the corrections to a record. Corrections, therefore, must be verified on LCS prior to being routed to the inputters who then key in the data in a specific format with fixed spacing. Another difficulty is the command structure of SUPERWYLBUR which differs from that of LCS. In order to enhance maintenance through SUPERWYLBUR, the Library has developed programs for use with IBM PC's. One program, logically called "combine", has been recently implemented to handle corrections in both UPDATES and HOLDING. The program which requires an LCS communication linkup has increased the accuracy and speed of data entry since verification of record status for change is provided at time of updating and keying is simplified.

Other programs have been developed to prepare LCS updates for SUPERWYLBUR which do not require communication with LCS, and thus are not affected by LCS downtime. So far these programs have been used to handle special projects such as the resultant changes in locations necessitated by the transfer of materials from 35 departmental libraries to the newly opened Sixth Stack addition and "added copies" changes. These programs have been highly successful because large numbers of transactions can be formulated from simplified keystroke patterns, thereby, resulting in increased speed of data entry. In addition, there has been no necessity for special staff training to use SUPERWYLBUR since the

program provides prompts for data entry. During the first three weeks the program was in use, 48.2 transactions per hour were recorded as compared with 25.3 transactions per hour without the program and utilizing the traditional SUPERWYLBUR data entry methods.

Programs have been designed for use with microcomputers to streamline the maintenance process, increase output and simplify training. For example, link maintenance has been greatly facilitated through programs designed to automatically search the Full Bibliographic Record and LCS records for possible links (Appendix D). The results are then stored on diskettes, and uploaded to SUPERWYLBUR for batch maintenance. While the majority of unlinked records are successfully handled this way, printouts containing information on non-matches are generated for staff to search and verify, usually only on LCS which allows for greater speed and efficiency.

Maintenance of the FBR component of the Online Catalogue involves changes and corrections to both the bibliographic and authority files and holdings file utilizing the WLN programs for maintenance. Within the WLN Input/Edit subsystem, twelve categories authorized for maintenance are currently defined as subfiles of the working file: Category 1 is reserved for review of duplicate FBR records; Category 2, 3, and 4 are for Automated Records Maintenance; Category 7-8 for Slavic cataloguing; and 11-12 for the Principal Cataloguer. Categories 5-6 and 9-10 are set up for communication on TELEX terminals among the Automated Records Maintenance staff, Slavic cataloguing staff, and the Principal Cataloguer. Passwords assigned to each user ensures protection of the database from unauthorized users. The working file, the file of records undergoing change, is further divided into three subfiles: Input, Change, and Replace. Each category or user maintains its own group of subfiles. For example, after the OCLC tapes are loaded into FBR, duplicate FBR records are automatically routed to the Replace subfile of Category 1 for review by the Automated Systems Maintenance staff. Individual holdings associated with bibliographic records may be added or deleted. Any holdings attached to a bibliographic record must be removed, however, prior to deleting the record.

The authority file is composed of three types of authority records: names, series, and subjects. Changes may be made online and are then batched processed. Through a global change capability, changes in the authorized form of the heading on the authority record results in retrieval of all associated bibliographic records under the revised heading.

The batch job for FBR maintenance (BIBVRO) is run weekly but can be run overnight as requested. Maintenance reports include an update log of authority and bibliographic records, i. e. changes

and deletions; a list of new headings generated; and miscellaneous statistics. Routine backup of workfile is provided six nights per week and backup of the entire database is provided weekly subsequent to loading the OCLC archival tapes and modifying the bibliographic, vocabulary (authority), keyword, and holdings files.

Production of catalog cards ceased in October, 1984. Since then, authority records prepared by copy and original cataloguers are routed to Automated Records Maintenance for input. Each heading is checked for which cross-reference requests are received. A manual authority file of AACR2 headings for names and series was maintained in Automated Systems until October 1984. This file is currently being incorporated into the Online Catalogue. Name authority headings are verified on OCLC for AACR2 form. The corresponding online authority record is then updated by transcribing the appropriate cross-references on the TELEX terminals. Procedures also involve eliminating unauthorized authority entries by merging them into one form or deleting them from the database.

Plans are presently being made to utilize microcomputers to facilitate the review of new authority headings added to the database from the OCLC tapes. A program has been designed for use with an IBM PC to scan authority headings by ISN for potential errors when multiple forms of a heading are encountered.

III. STAFFING

While the Online Catalogue has made possible current decentralization in UIUC Library of the original cataloguing staff into the public service units, including departmental libraries, the functions of copy cataloguing, searching and inputting on OCLC, maintenance, and the coordinating of the Online Catalogue have remained centralized in the Automated Systems Department since 1978 with little changes of staffing levels. The Automated Records Maintenance unit includes 9 staff members (8 FTE). LCS maintenance is handled by one paraprofessional and 5 clerks, while 2 paraprofessionals and 1 graduate assistant handle FBR and authority file maintenance. One professional librarian coordinates the activities of the unit (Appendix E).

When card production ceased, staff members who were formerly responsible for maintenance of the card catalogue now, in addition to searching OCLC, participate in aspects of Online Catalogue maintenance. Similarly, the clerk typists who previously typed authority cards in addition to inputting records into OCLC also participate in the maintenance of the Online Catalogue.

IV. HARDWARE

Terminals used by Automated Maintenance include 4 LCS/SUPERWYLBUR switchable for LCS maintenance, 4 TELEX terminals for FBR maintenance, and 2 microcomputers utilizing FBR and SUPERWYLBUR ports to run the various IBM/BASIC maintenance programs. There are also 2 Hazeltine terminals and a printer to access the LCS/FBR database only. All terminals have glare shields. While terminals are scheduled throughout daytime and evening hours, staff have regularly scheduled breaks to avoid eyestrain.

V. SUMMARY

By the 1970's, filing and changes in the card catalogue at the UIUC Library had proven to be extremely labor intensive requiring more staff, time, and funds than were available or economical. Simply put, maintenance of the card catalogue had become less than satisfactory. Due to the volume of cataloguing produced at the UIUC (average 11,000 titles per month for the past fiscal year) it was impossible for the staff to check every record and then keep the card catalogue up-to-date. In contrast, the maintenance of the Online Catalogue which has not been dependant on the arrival of cards to check and file has allowed for a more current database which can be maintained in a more timely manner. The development of detailed workflow procedures coupled with localized microcomputer programs have allowed for efficient maintenance procedures and quality control of the database. More importantly, however, is that effective maintenance has contributed to improved user access to library resources.

APPENDIX A:

FBR MAINTENANCE OF THE ONLINE CATALOGUE: REPORTING CORRECTIONS

The Automated Records Maintenance Unit is responsible for maintaining the FBR component of the Online catalogue. Please mail corrections to ARM/FBR 202 Main Library.

I. Types of Corrections for FBR Maintenance:

A. Corrections of Bibliographic Record:

This category covers any types of changes that apply to only one bibliographic record. If possible, prepare updates or send printout of the bibliographic record in "complete display format". (EX. a typographical error in the series volume number should be changed in the bibliographic record.)

B. Deleting a Bibliographic Record:

Give reasons or supply proof of authority, if the request is to delete a bibliographic record from the database.

C. Corrections of Headings and/or Cross-References in the Authority File:

This category covers correcting discrepancies of the heading and adding or updating cross references. If possible, prepare updates or send printout of the heading in "complete display format". (EX. several forms of headings for the same person should be merged into one.)

II. Procedures:

Corrections may be made on a printout or on the FBR Maintenance Change Request Form. A copy of this form is attached. Please make copies as needed.

III. Priority:

Any corrections in access points such as title, ISBN/ISSN, name/subject/series headings, etc. will receive highest priority.

IV. Corrections To Records In Both LCS and FBR:

If any change in LCS is also needed, please send a separate update to ARM and note on the FBR correction that an LCS update has also been sent.

REQUESTED BY _____ (Name)
 RETURN TO: ARM-FBR, 202 Library DATE _____

FBR MAINTENANCE CHANGE REQUEST FORM

Circle as needed:	1	2	3
	Corrections of headings and/or x references	Corrections of bib record	Delete record (give reasons)

INSTRUCTIONS:

1. If possible, prepare this form in 'complete display' format (with tags).. Either FBR (mnemonic) tags or OCLC (numeric) tags are acceptable.
2. Type or write clearly. Do not use all caps (FBR uses upper and lower case in display).
3. Staple any accompanying printouts. If corrections are made on printout, information need not be repeated on this form.
4. Attach proof as needed.

RID NO. _____					
Text to be corrected unless printout is attached					
_____ tag _____	Requested change:				
_____ tag _____					
Text to be corrected unless printout is attached					
_____ tag _____	Requested change:				
_____ tag _____					
Text to be corrected unless printout is attached					
_____ tag _____	Requested change:				
_____ tag _____					
Fixed Field Code:					
ERIC			13		
Change:					

TABLE 1. TYPES OF POSSIBLE CORRECTIONS FOR FBR MAINTENANCE 10/84
 (for ARM use only)

Type 1 Corrections of Headings and References

1.1 Names

(NAP, NAC, NAM, NAU)	(MEP, UTI, MEC, MEM, MEU, AEP, AEC, AEM, AEU)
(100, 110, 111, 130)	(100, 240, 110, 111, 130, 700, 710, 711, 730)

- (A) typographical errors
- (B) adding/deleting the dates (ie., subfield d)
- (C) errors in tags/indicators
- (D) heading not conformed to AACR2
- (E) cross references

1.2 Series ('va' and 'vt')

(NAO, NAB, NAL, FIS)	(SEP, SEC, SEM, SAP, SAC, SAM, SAU, SET, SER)
(100, 110, 111, 130)	(400, 410, 411, 800, 810, 811, 830, 440, 490)

- (A) typographical errors
- (B) adding or deleting the x subfield
- (C) errors in tags/indicators
- (D) heading not conformed to AACR2
- (E) cross references

1.3 Subjects

(SUP, SUC, SUM, SUU, SUT, SUG)	(SUP, SUC, SUM, SUU, SUT, SUG)
(100, 110, 111, 130, 150, 151)	(600, 610, 611, 630, 650, 651)

- (A) typographical errors
- (B) adding or deleting the dates (i.e., subfield d)
- (C) errors in tags/indicators
- (D) heading not conformed to AACR2
- (E) cross references

TYPE 2 Corrections of Bibliographic Records

2.1 Names

- (B) adding or deleting author/title entries (e.g., UTI, AE_, etc.)

2.2 Series

- (B) adding or deleting a series;
 adding or deleting or modifying a subfield (e.g., n, x, v, etc.)
- (C) errors in tags/indicators

2.3 Subjects

- (B) adding or deleting a subject;
 adding or deleting or modifying a subfield (e.g., x, y, z, etc.)

2.4 Title area

- (A) typographical errors
- (B) adding or deleting title information
- (C) errors in tags/indicators

2.5 Other areas

(IMP, COL, NO, SBN, SSM, DAT, VAT, FOR, AED, etc. and fixed fields)
(260, 300, SIX, 020, 022, 362, 246, 247, 740, etc. and fixed fields)

- (A) typographical errors
- (B) adding or deleting or modifying a field
- (C) errors in tags/indicators

BEST COPY AVAILABLE

For records newly added through OCLC, the link should be built within several days after both LCS and FBR records are in place. Please wait at least two weeks before reporting unlinked new records. If after two weeks, the link is not present, send a printout of FBR and LCS records.

To report Link problems, please mark printouts as follows:

Write "LINK PROBLEM" at the top and any comments in red.

Please include name, date, and department.

Send Link problems to ARM, Room 202 Library. If you have any questions, please call Winnie Chan or Patti Norcott (3-3555).

The following situations may necessitate reporting unlinked records:

1. The FBR and LCS records exist, but are not linked:

If a search of the holding display shows "URBANA URBANA" and the link display shows "This item not linked to circulation data", a printout of both the FBR and the LCS records should be sent.

If a search of the holding display shows "RIVER BEND" and the link display shows "THIS ITEM NOT LINKED TO CIRCULATION DATA", there is no need to report the unlinked record at this time, as it is not in error.

(At present, there is a backlog of unlinked records, generated by the link maintenance program. Your report of unlinked records will alert us to correcting those records sooner.)

If a search of the link display shows an LCS error message (e.g., ERR/001... or INCOMPLETE MESSAGE...), this results when LCS is unable to process the information provided by the link display. A printout of the FBR record showing the call number and volume number of the analyzed piece should be sent.

2. The FBR record exists, but the LCS record does not:

If a search of the holding display shows "URBANA URBANA" and no corresponding LCS record can be found, a printout of the FBR record marked "No LCS record located" and showing the correct call number and copy/volume/location information should be sent.

3. The FBR record is linked to an incorrect LCS record:

If the FBR record is linked to an incorrect LCS record or records and there is no correct LCS record in the link display, a printout of (a) the FBR record, (b) the incorrect LCS record or records and (c) the correct LCS record should be sent.

There is no need at this time to report FBR records in which a correct link along with one or more incorrect links exists.

APPENDIX C:

ERROR/SYSTEM matrix for guidance in error correction and system changes

Table 1. Errors in 09X and/or 949 fields

Types of Errors	Fixing LCS/FBR records locally or through OCLC	LINK maintenance
1. Errors in 09X field e.g. typo in 09X; Call no. in LCS incorrect	<u>Send ARM update to correct LCS record</u>	No action
2. Duplicating Call no. already in LCS (1 record on LCS and 2 records in FBR; link file in error)	<u>Reuse OCLC with 910 FBR/REP to generate new LCS record. Send ARM update holdings, if LCS holdings information is in error</u>	<u>Send ARM to remove incorrect linked record</u>
3. Title catalogued as new instead of being treated as added copy (2 records on LCS and 1 or 2 records in FBR)	<u>Reuse OCLC with 910 FBR/REP AND 949 DEL (unwanted callno.)</u> Note: <u>If a different OCLC record was used, creating two FBR records, send FBRM to delete the unwanted FBR record.</u> <u>When do update on OCLC to cancel UIU hold. lib. symbol, always use 949 IGNO AND 910 FBR/IGNO.</u>	<u>Send ARM to remove incorrect linked record</u>
4. 949 DEL fails because LCS record was not discharged.	<u>Send ARM to delete LCS record (e.g., order record)</u>	No action
5. Typo in 949 REP	<u>Reuse OCLC with 910 FBR/REP AND 949 REP (callno.)</u>	No action
6. Callno. in 949 field not found in LCS e.g. typos in 949; records lost in LCS, etc.	<u>Reuse OCLC with 910 FBR/IGNO</u>	No action

BEST COPY AVAILABLE

Table 2. Heading/Description Discrepancies

Types of Errors	Fixing LCS/FBR records locally or through OCLC	LINK maintenance
<p>1. Heading of any kind incorrect (affecting only 1 FBR record)</p> <p>e.g. typos; errors in tagging, subfield codes, etc.</p>	<p>Check authority file under the heading. Find out if only 1 FBR record is attached to the heading. <u>Notify FBRM to correct the heading online.</u> <u>Notify ARM to correct the heading if appears on LCS.</u></p> <p>If necessary, prepare OCLC error report.</p>	No action
<p>2. Heading of any kind incorrect (affecting more than one FBR record)</p> <p>e.g. a non-AACR2 entry.</p>	<p>Check authority file under the heading. Find out if there are more than one FBR record involved. <u>Notify FBRM to correct the heading online.</u> (Provide any cross references to be added, if possible). <u>Search LCS under the incorrect form of the heading. Send ARM update to correct the heading.</u></p> <p>If necessary, prepare OCLC error report.</p>	No action
<p>3. Errors in cataloging description Or, in case of recataloguing, replacing an old FBR record with an updated OCLC copy</p>	<p><u>Reuse OCLC with 910 FBR/REP AND 949 REP(Callno.) or 949 DEL(unwanted callno.), whichever 949 is appropriate</u></p> <p>If necessary, prepare OCLC error report.</p>	No action

5/24/8.

JJBA JAK

APPENDIX D: Linker File Examples

This LINKER program uses LCS call no.
 Do you have a printer attached? (Y/N) Y
 Advance how many? (Press ENTER if 0) 0
 Enter file no. (separated by a comma, if more than one): 002
 STARTING THE URBANA.002FILE.....
 Recheck= 0 Lints= 0 Inconclusive= 0 To verify= 0 Total= 0
 F R OCL79133432 \$.c

BIBLIOGRAPHIC DISPLAY

COLLECTION ID.ALL

```

am ocl79-133432 db 07/21/84 07/21/84 --/--/-- URBANA URBANA
LCDN $abcde $2$3$3$3$3
MEPS $ad $Kell, Walter Gerry,$1921-
TILA0 $ac $Modern auditing /$Walter G. Kell, Richard E. Ziegler
; consulting editor, William C. Boynton.
EDN $a $2nd ed.
IMP $abc $New York :$Wiley,$c1983.
COL $abc $xvii, 706 p. :$ill. ;$25 cm.
NOG $a $Includes index.
SUT L $a $Auditing
AEP5A $a $Ziegler, Richard E.
SBN $ac $0471877492 :$$28.95 (est.
CAL $ab $HF5667$.K39 1983
DDCF $a2 $657/.45$19
CAS $acd $DLC$DLC$UIU
LON $a $ocl79133432
FFD CONF= FEST= INDEX=x ME IN B=x
INTEL LV= FIC= BIOG= LAN=eng DAT KY=s
DATE1=1983 DATE2= CNTY=nyu ILLUS=a REPRO=
CONTENTS= MODRC= CAT S= GOV PUB= CAT FORM=a
NLO $a $cop.1 Commerce
  
```

HOLDINGS DISPLAY

COLLECTION ID.NET

1. Kell, Walter Gerry, Modern auditing / ocl79-133432
 URBANA URBANA

F R OCL79133432 657.4K28M;1983 Urbana 1983
 TLS/MODEAUDIT

```

PAGE 1 6 MATCHES 0 SKIPPED (ALL DISPLAYED IN 1)
01 KELL, WALTER GERRY, 1921- MODERN AUDITING$ BOSTON 1980
02 KELL, WALTER GERRY, 1921- MODERN AUDITING$ 2ND ED.$ NEW YORK: 1983
03 DUNGAN, CHRISTOPHER WRIGHT, 1935 A MODEL OF AN AUDIT JUDGMENT IN THE FO 1983
04 PARK, SOONG H. (SOONG HYUN), 194 A MODEL OF THE AUDIT PROCESS WITH EXPL 1977
05 VIRGINIA--AUDITOR OF PUBLIC ACCO MODEL FOR REPORTS OF AUDITS OF THE ACC 1937
06 DUNGAN, CHRISTOPHER WRIGHT, 1935 A MODEL OF AN AUDIT JUDGMENT IN THE FO 1983
  
```



DSL/2
 657.4K28M1983 FELL, WALTER GERRY, 1921- MODERN AUDITING\$ 2ND ED.\$ NEW YORK
 82-24735 2713930 1983 2 ADDED: 831211
 01 001 16-4W CRX RCALL 850221/850228 UC 000007106
 02 002 16-4W CRX CHGD 850318/850415 UC 360629505
 03 001 SAVE 850302 UC 304640446
 PAGE 1 END

CN=657.4K28M1983
 ME=KELL, WALTER GERRY, 1921-
 TI=MODERN AUDITING
 ED=2N
 FL=NE
 LC= 8224735
 TN= 2713930
 PD= 1983
 FLAG= 1

possible link OCL79133432 2713930
 Recheck= 0 Links= 1 Inconclusive= 0 To verify= 0 Total= 1
 F R OCM10140000 \$,c

BIBLIOGRAPHIC DISPLAY

COLLECTION ID.ALL

am	ocm10-140000	db	07/21/84	07/20/84	07/24/84	URBANA	URBANA	
MEPS	\$aqdw	\$Weale, W. H. James	\$(William Henry James), \$.832-1917.\$					
		4n						
TILA2	\$ahbc	\$A descriptive catalogue of rare manuscripts & printed books\$microform :\$chiefly liturgical /\$by W.H. James Weale.						
IMP	\$abc	\$London :\$B. Quaritch,\$1886.						
COL	\$abc	\$xv, 191 p. :\$ill. ;\$23 cm.						
NOG	\$a	\$"Exhibited by Her Majesty Queen Victoria; the Universities of Cambridge, Cracow, and Oxford; the National Hungarian Museum, Buda-Pest; the Archbishop of Mechlin; the Earl of Ashburnham, Earl Spencer, W.H. Cummings, A.H. Littleton, J.E. Matthew, etc."						
NOG	\$a	\$Limited edition of 180 copies; 150 on demy, 30 on royal paper.						
NOG	\$a	\$Includes indexes.						
NOG	\$a	\$At head of title: Historical Music Loan Exhibition, Albert Hall, London, June-October, 1885.						
NOX	\$abcde	\$Microfilm.\$Chicago :\$Newberry Library,\$1969.\$1 microfilm reel : negative, ill. ; 35 mm.						
SUT L	\$axx	\$Church music\$Catholic Church\$Bibliography.						
AEMNA	\$adcw	\$Historical Music Loan Exhibition\$(1885 :\$Albert Hall, London)\$4n						
LON	\$a	\$ocm10140000						
FFD	CONF=	FEST=	INDEX=x	ME IN B=x				
	INTEL LV=	FIC=	BIOG=	LAN=eng	DAT KY=r			
	DATE1=1969	DATE2=1886	CNTY=ilu	ILLUS=a	REPRO=a			
	CONTENTS=b	MODRC=	CAT S=d	GOV PUB=	CAT FORM=a			



HOLDINGS DISPLAY

COLLECTION ID.NET

1. Weale, W. H. James A descriptive catalogue of rare manuscripts &
printed books microform : ocm10-140000

URBANA URBANA

F R OCM10140000 016.7830262W372D 1969 1886 Urbana 1969 1886
TLS/DESCCATAL
PAGE 1 204 MATCHES 0 SKIPPED (NOT ALL DISPLAYED)
01 ADYAR LIBRARY, MADRAS. DESCRIPTIVE CATALOGUE OF SANSKRIT MANU 1942
02 SYDNEY. TECHNOLOGICAL MUSEUM. DESCRIPTIVE CATALOGUE
03 GANGANATHA JHA RESEARCH INSTITUT DESCRIPTIVE CATALOGUE OF SANSKRIT MANU 1967
04 WALKER MANUFACTURING COMPANY DESCRIPTIVE CATALOGUE OF GENERAL MANUF
05 ASIATIC SOCIETY, CALCUTTA. A DESCRIPTIVE CATALOGUE OF SANSKRIT MA 1917
06 INDIAN MUSEUM, CALCUTTA A DESCRIPTIVE CATALOGUE OF SANSKRIT MA 1969
07 ROYAL IRISH ACADEMY, DUBLIN. MUS A DESCRIPTIVE CATALOGUE OF THE ANTIQUI 1857
08 VISVA-BHARATI.VIDYA-BHAVANA. DESCRIPTIVE CATALOGUE OF SANSKRIT MANU 1975
09 SIMPSON, CHARLES TORREY, 1846- A DESCRIPTIVE CATALOGUE OF THE NAIADES 1914
10 CAMBRIDGE. UNIVERSITY. TRINITY H A DESCRIPTIVE CATALOGUE OF THE MANUSCR 1907

Too many hits on TLS, will try ATS

ATS/WEALDESCR

FILM016.7830262W372D WEALE, W. H. JAMES WILLIAM HENRY JAMES), 1832-1917.

A DESCRIPTIVE CATALOGUE OF RARE MANUSCRIPTS & PRINTED BOOKS* LONDON

NOLC 2706018 1886 1 ADDED: 831127

01 001 BUQ MUQ

PAGE 1 END

BEST COPY AVAILABLE

APPENDIX E: Organizational Chart

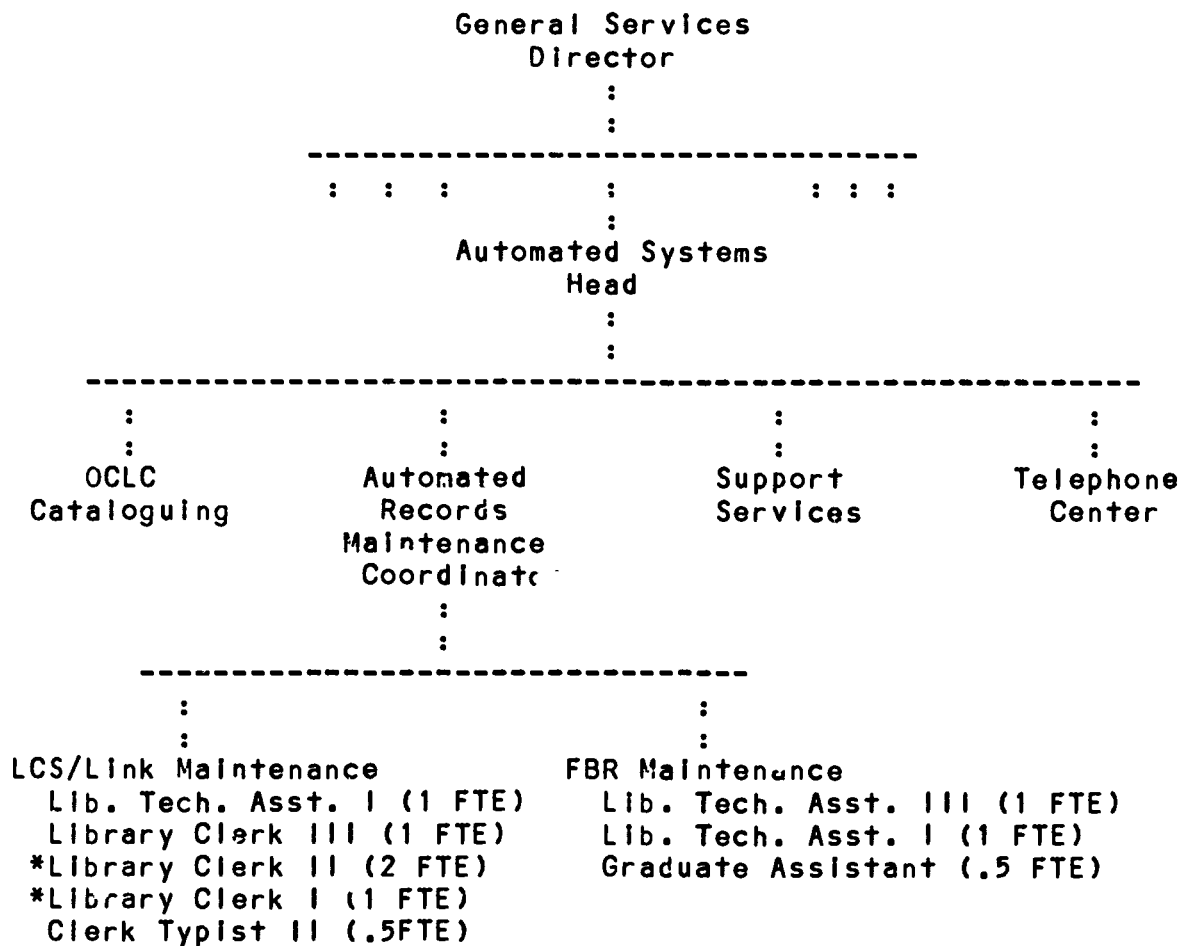

* Also do FBR maintenance

3084210 10/1/80

OOPs REPORT PROCEDURETABLE OF CONTENTS

<u>PAGE</u>	
-2-	A. GENERAL TIPS ON DECISION-MAKING
-3-	B. TRANSFER AND WITHDRAWAL PROCEDURES
-4-	C. REFERRING OOPs QUERIES TO OTHER FORMAT SPECIALISTS:
	1. In I.P.:
	Music
	Serials
	2. Out of I.P.:
	Music
	Serials
	Thesis
-5-	D. WHEN TO REQUEST A SURROGATE AND WHEN TO PHONE CAMPUS
-5-	E. CALL NUMBER CHANGES -- what we do and do not process
	F. HOW TO HANDLE ACCESS FIELDS:
-5-	1. 1XX, 24X, 6XX, 7XX:
	Form of Name
	Typos
	Singular vs. Plurals
	Birthdates
	Deathdates
-6-	2. SERIES: 4XX, 8XX
-6-	3. HOLDINGS:
	Adding Location
	Adding Reference to a Location
	CES serials
-6-	4. ADDING ENTRIES OR HEADINGS
	G. AVAILABILITY OF BOOKS IN STACKS:
-7-	1. Item not available
-7-	2. Status unknown
-8-	3. Examples of ICP/LIAS relationship
-8-	H. TERMINAL NUMBERS AT PUBLIC SERVICES
-8-	I. COMMON SPELLING CHANGES
-9-	J. EXAMPLES OF FORMS
-10-	K. AUTHORIZED NAMES AT CAMPUSES

OOPs REPORT PROCEDURE

A. GENERAL TIPS ON DECISION-MAKING:

1. OOPs NOT HANDLED:

- a. Always approach OOPs by questioning the requestor's message.
- b. Indicate that an OOPs message has been taken care of by checking it off at the front of the line.
- c. When the requestor does not state his/her location on the report and you are not absolutely certain of its validity, do NOT complete the request. Instead of checking it off, place your supervisor's initials in front of the line.
- d. Supervisors will red-circle those OOPs requests that can not be carried out and give them to M. Bednar.
- e. LOGONS: OOPs reports are routinely done on the maint logon. However, to place a retro record on COM, you must use the mlp logon and "done" the record.

INFO: Type "info" to find out what logon you are on, when needed.

- f. Refer questions about the correctness of a classification to your supervisor, see section on Call Number (E.3.).
- g. There is no particular routing path for the OOPs referrals from and to various specialists within the I.P. section.
- h. If a patron requests that we order a title or volume, make a printout and transfer the message to it. Refer to your supervisor, who will direct the printout to Joyce Ogburn if Sci Tech subject, Kim Fisher if Social Sciences subject, and Carol Chamberlain if subject is elusive.

B. TRANSFER AND WITHDRAWAL PROCEDURES:

1. TRANSFERS:

MONOGRAPHS:

We do not accept transfers to and from branches nor campuses, since, from the branches, we need the book to change the location on the spine, and, from the campuses, we need them to send us a label request form (example of form in Section J). However, we will transfer books via OOPs when the book is in Pattee and a branch requests it to be transferred to their location. (Note that such a request must come from a branch librarian or assistant.) Retrieve the book from the stacks, and if you are familiar with transfer procedures, complete the transfer (change LIAS or "act wlp" for the COM, have the book remarked, have the cards pulled for retro items.)

7-3:30: For all transfers, place GRS' initials in front of the entry;

9-6ers: If in doubt place HHS's initials in front of the entry;

1-9:30: Change LIAS, have the item remarked, write the author, title, and call number on a 3x5 yellow slip, and give to Flo to withdraw Pub. Cat. cards.

SERIALS:

Refer to Judy Hewes: ALL serial transfers and any OOPs messages regarding the 090\$1, \$c, or \$s.

2. WITHDRAWALS:

PATTEE AND BRANCHES (UP):

Do NOT do withdrawals via OOPs for UPM and branches;

For monographs, if a branch requests a withdrawal through OOPs, either call the branch or have your supervisor call the branch to remind them not to withdraw via OOPs.

For UP serials, refer withdrawal requests to Judy Hewes with a printout of record and OOPs message.

CES SERIAL TITLES:

Refer CES library serial withdrawal requests to SGH on 7-3:30, KAP or LWC on 9-6 regularly, and EPC if problematic on 1-9:30.

CZS MONOGRAPHIC TITLES:

CES withdrawals must be counted on the withdrawal sheet. However, if item was never owned by location, such as in the case of "hn does not own" messages, simply delete the location and do not count, with the exception of barcoded items.

If a CES location asks to withdraw an item and they are the only location on the record, on 7-3:30 and 9-6, make a printout and direct to your supervisor with instructions to delete. On 1-9:30, write EPC in front of line - make no printout.

OOPs REPORT PROCEDURE

C. REFERRING OOPs QUERIES TO OTHER FORMAT SPECIALISTS:

Anytime you are referring a problem, the best method is to produce a printout and either rewrite or transfer the OOPs message to the printout. In any event, the receiver should understand the source of the problem (OOPs list) and the identity of the OOPs sender, if known.

1. In I.P.:

Do not complete the request if initials of an IP person are written in front of the request and those initials are not yours.

MUSIC:

If the record is in Music format, refer to a music specialist by placing DCM's initials in front of the line. He will refer foreign language in music format to AAH in Cataloging.

SERIAL:

Records in serial format always require special considerations. So if you do not have serials training, do not correct even minor typo errors on any serial records on 7-3:30 and 9-6. Place the following initials in front of the OOPs message: SGH on 7-3:30, and NMS on 9-6. They will complete them by following steps in C.2. as described below. However, on 1-9:30, correct minor typos and straightforward holdings updates, such as, "hn does not own 1984"; refer problems to EPC as needed.

2. Out of I.P.:

MUSIC:

Refer music problems that can not be resolved in IP nor by Library Assistants to Cathy Gerhart.

SERIALS:

Continuation's concerns are with the holdings, currency and physical location of the volumes; however, cataloging's concerns are with the bibliographic information.

Refer UPM serial holdings, questions about the CSS, cessations, cancellations, and withdrawals to Judy Hewes or Irene Wernstedt.

Refer serial questions about frequency changes, additional access points, title changes, reclassification requests, or any other bibliographic information to Karen Nadeski.

THESIS:

Refer thesis problems that can not be resolved in IP to John Attig.

OOP's REPORT PROCEDURE

D. WHEN TO REQUEST A SURROGATE AND WHEN TO PHONE CAMPUS:

1. Request a surrogate when you need to see an actual title-page to be certain of a match, specifically when you think you should be adding the location to a different record.
2. Phone campus when you just need to double check or confirm data such as paging of a paperback publisher versus a hardback publisher.

E. CALL NUMBER:

1. When the requestor does not state his/her location on the report and you are not absolutely certain who the person is, do NOT complete the request. Instead, place your supervisor's initials in front of the entry.
2. If the CES requestor has asked you to add a new 090 to a monographic record, you must do a shelflist on that call number. When a duplicate call number results, and retro rules on dup. call numbers do not apply:

7-3:30 and 1-9:30: Immediately have supervisor cutter a digit and send change call number slip (example of form in Sect.J);
9-6:00: Immediately have supervisor cutter a digit and send change call number slip. In front of line, write "dup".
3. Refer questions about the correctness of a classification to John Attig.

F. ACCESS FIELDS:

1. 1XX, 24X, 6XX, 7XX

a. FORM OF NAME:

Requests to change authorized headings should be referred unless they can be clearly resolved by searching LIAS for the suggested author, subject, or series or by bridging author, subject, or series from the displayed record.

Example: OOP3 "Author's name is Jackson, Edward."
Record has: 100 10 Jackson, Edwin, 1899-
245 10 What's in a name \$cby Edward Jackson

If a bridge author reveals all other entries under this author are "Edward" or a compare pulls up a MARC record with "Edward" in it, correct the entry. Without such confirmation, though, a check of NAF, OCLC, and/of LCAF must be performed, and is best done by a grade 6 who is proficient at verification procedures. For authority problems, refer to GRS on 7:00-3:30, HHS on 9-6 and EPC on 1-9:30.

b. TYPOS:

Correct all typos in 260, 250, and non-transcription fields (5XX) and consult English dictionaries when useful. Refer typos in foreign languages to GRS, HHS, or EPC. For authorized headings (1XX,6XX,7XX), follow procedure in F.1.a. For series (4XX,8XX), follow procedure in F.2. below.

If the typo is in the 245 field and is not an obvious typo, check OCLC, Pub. Cat., and even book to verify, as appropriate.

F.1. ACCESS FIELDS: continued

c. SINGULAR VERSUS PLURALS:

Use a bridge command to verify typos on subject headings, such as the request: "Periodical should be Periodicals". If problem is in 4XX/8XX, see F.2. below. Section J. of this routine lists some common typos.

d. BIRTHDATES:

NEVER add birthdates to X00 fields.

If there is an obvious typo in the birthdate, correct it ONLY after verifying it by bridge, NAF check, or LCAF check.

e. DEATH DATES:

Add death dates to X00 fields ONLY after you verify by a bridge, NAF check, or LCAF check that the change is official.

F.2. SERIES: 4XX and 8XX:

An interesting question arises. How far to track down alleged series entry inconsistencies? First step: either call up the record and bridge from the series OR search series on the suggested form of the entry. Try to decide which is the correct and latest form of the series from the citation list. However, if you can not draw a safe conclusion, check the entry in the SAF. If you are still unsure, on 7-3:30 and 1-9:30, place your supervisor's initials in front of the OOPs line; on 9-6, place HHS' initials in front of line.

3. HOLDINGS: 090c:

- a. When a campus asks you to add their location to a LIAS record that you suspect may be another edition, contact the campus to clarify the paging, publisher, and/or date.

If the requestor's information conforms to the match criteria in the bibliographic record, then you may add the holding.

- b. If a campus requestor asks that we change their location to Reference, change the location code to upper case, eg.: \$coz becomes \$COZ. For UPM transfer from stacks to a branch, see B.1.

- c. CES serials: If a campus requestor sends a message such as "Retaining latest edition only", write SGH or LWC in front of the line. The location will be edited to read: \$c \$sLE

Other variations include: \$chn:Lrf+U1983+U1984+U1985 \$s+U1984-U1985 which will display on LIAS as "Hazleton Campus, Latest in Reference"

Other examples of location note codes can be found in the PSUL Serials Reference manual.

4. ADDED ENTRIES OR HEADINGS: 740 or 6XX:

- a. When to add access points: Add 740s if they are justifiable. On requests for additional subject headings (6XX), make printout and refer to J. Attig.

OOPs REPORT PROCEDURE

G. AVAILABILITY:

1. "ITEM NOT AVAILABLE" MESSAGE:

Verify ICP and LIAS for discrepancies in data. If data in LIAS and ICP match, place your supervisor's initials in front of line and make a printout of the LIAS record.

Supervisors will send to C. Swinton/Lending Services printouts of records on OOPs reports when the message is "Item can not be located" or "Item not on shelf". C. Swinton will place a locate on the item to track it down.

2. "STATUS UNKNOWN" MESSAGE:

The "status unknown" message on LIAS is either a result of no existing ICP record or of a discrepancy between ICP and LIAS. Occasionally, an OOPs message will appear, stating that the patron received a "status unknown" LIAS message and would like us to look into why it is in this status.

WHEN NO ICP RECORD EXISTS:

At this time, IP does not barcode stacks items retrospectively, as this is performed routinely in Lending Services when a patron charges an unbarcoded book at the desk. If the lack of an ICP record is the only reason for the "status unknown" OOPs message, there is no more follow-up.

WHO IS TO INVESTIGATE "STATUS UNKNOWN" OOPs MESSAGES:

If you are not authorized to do Item Maintenance on ICP, refer this OOPs message to GRS on 1-3:30, KAC on 9-6, and EPC on 1-10, who will follow these steps:

MANIPULATING ICP/LIAS:

CALL NO. DISCREPANCIES:

When the location in question on the LIAS record lists a barcode for the book, check the barcode with an item inquiry (ii [barcode]) or on Item Maintenance (im [spec card]) to make sure that the call numbers in LIAS and ICP match. If they do not, check the book for the correct call number and correct ICP or LIAS accordingly.

NO BARCODE ON BOOK:

If the location in question does not list a barcode for the book, do a call number inquiry (ci [call number]) on the proper 090 to discover the barcode number for the book. If you see the message "Item Denied", pursue this request no further if the OOPs message is from an unknown source. If the OOPs message is from an authorized source, such as a public services librarian or Interlibrary Loan, place your supervisor's initials in front of the line.

LOCATION DISCREPANCIES:

However, if ICP displays a barcode number on the item inquiry command, go into Item Maintenance, call the barcode and check ICP to see if the owner matches the location code in the LIAS 090\$c. If it does not, find out the owner of the item and correct ICP or LIAS accordingly.

G. AVAILABILITY: continued

3. EXAMPLES OF ICP/LIAS RELATIONSHIP:

When an MLP <u>mm</u> record is in LIAS for \$cst <u>AND</u> the item is entered in ICP:	When an MLP <u>mm</u> record is in LIAS for \$clf <u>BUT</u> item is not entered into ICP:
stat says 1 available	stat says Status Unknown
dire says In Process-Level 1 CORE	dire says In Process-Lf Ref.
ii says Item: xxxxxxx Available	ii says DENIED No Find

H. TERMINAL NUMBERS AT PUBLIC SERVICES:

- L14 Lending Services desk
- L15 Lending Services desk
- L16 Lending Services renewals terminal
- L17 Lending Services CES terminal
- L19 Reserve Reading Room
- L21 Engineering Library
- L23 Earth and Mineral Sciences Library
- L25 Architecture Reading Room
- L27 Physical Sciences Library
- L29 Math Reading Room
- L3i Pollock Library

I. COMMON SPELLING CHANGES:

America	vs.	American
American	vs.	Americana
archaeology	vs.	archeology
edition	vs.	editions
Great Britian	v.	Great Britain (correct)
innovation	vs.	innovative
institue	vs.	institute
internatinal	v.	international
lecture	vs.	lectures
mcnograph	vs.	monographs
periodical	vs.	periodicals
personal	vs.	personnel
publication	vs.	publications
sportsman	vs.	sportsmen
study	vs.	studies

OO's REPORT PROCEDURE

J. EXAMPLES OF FORMS:

FORMS USED BY PROCESSORS:

CHANGE CALL NO. FORM:

Barcode: _____	
CHANGE CALL NUMBER	
To: _____	Campus
From: _____	To: _____
Title: _____	
Author: _____	
Edition: _____	Initials: _____
Date: _____	Date: _____

REQUEST FOR FURTHER INFORMATION:

REQUEST FOR FURTHER INFORMATION:	
Would you please send us:	
title page and verso	Call No.: _____
paging	
book	
AV item	
Title: _____	
Author: _____	
Thanks. _____	Date: _____
(Item No.: _____)	Requested by: _____

THE FORM THROUGH WHICH CAMPUSES REQUEST LABELS:

LABEL REQUEST FORM:

ONLY ONE CALL NO. PER SLIP	
LABEL REQUEST	
FROM: _____	CAMPUS
AUTHOR: _____	PLACE OF PUBLICATION: _____
TITLE: _____	EDITION: _____
MONOGRAPHIC CALL NUMBER: _____ (indicate copy no.)	SERIAL CALL NUMBER: _____ (indicate date and/ or ed. as desired)
_____ THIS IS A REPLACEMENT LABEL. (important info.)	OPTIONAL INFORMATION:
_____ NEED A NEW BARCODE!!	Is this on standing order?
Withdraw the old barcode # _____	_____ yes

OOFS REPORT PROCEDURE

K. LIST OF AUTHORIZED NAMES AT CAMPUS LOCATIONS:

This list is the last page of the routine for the convenience of being frequently updated:

Allentown llrc	ml job	Mary Landis J. O'Boyle	llrc = Library Learning Resource Center
Altoona	ss	Shirley Smith	
Beaver	eh	Eileen Higgs	
Behrend	pg cs	Patricia Gainer Carol Swift	
Berks	ss	Sally Small uses S.Small	
Capitol	?		
Delaware	ss sw	Sally Simmons uses Simmons Susan Ware	
DuBois	be	Barb Emmer	
Fayette	jb	Joanne Baugh	
Hazleton	rt	Rich Tyce uses rtyce	
King of Prussia	vh	Vera Hospodka	
McKeesport	jh	Jettie Hill	
Mont Alto	mb	Marjory Blubaugh	
New Kensington	am	Albert Miller	
Ogontz	jc	J. Cliggett	
Schuylkill	ls ds rt	Lorraine Stanton D. Schmidt R. Troy	
Shenango Valley	pc	Patricia Callahan	
Wilkes-Barre	jd	Joan Diana	
W. Scranton	jic my rf mw	Judy Carr Mary Yeager Richard Fitzsimmons uses r.fits M. White	
York	gg rl dv	Gail Gangloff Rachel Lehr d.v.	

Sample Page of a Generated OOPs Report

From:INF <psu261220> the call number lacks a decimal point
 From:INF <83643225> the call number lacks a decimal point
 From:INF <psu262031> the call number lacks a letter "c" after the "jn"
 > in unat. there are others
 From:INF <psu274000> this looks like the only other with this call
 > number error of lacking the "c" in uncat.
 From:INF <psu274841> shouldn't this call number include a "treas" or a
 > "th"? there is one other like it as well.
 From:INF <psu289337> this is one of five call numbers in which the
 > second word is a mistyping of the word "treas".
 From:PER <92021176> the lc card number is incorrect--the correct number
 > in marc is for a title called--my shaping up/
 > shields, art.
 From:REF <psu216412> publisher is PILOT
 > publisher is PILOT Books
 From:REF <psu170833> Encyclopedia americana
 From:REF <58012754> the R2P
 > the call number for the ces libraries has the
 > decimal point in the wrong place
 From:L31 <79027430> PULLER SHOU HAVE REFERENCE
 From:JAG <64014713> Last name of personal name is misspelled in 100 field
 From: <70643997> ~~check the spelling of national climatic center~~
 From:L27 <65019190> ITP CALL NO. 445 1960 IN CALL, BUT 1955 IN DV 307
 > CMCKOWN
 From:L25 <sc81006042> THESE ARE ALL JNIT CHARGED TO ARCH RESERVE
 From:L25 <osu289162> THIS IS AVAILABLE IN ARCHITECTURE
 From:L25 <R2080599> THIS IS AVAILABLE IN ARCHITECTURE
 From:L25 <R2013130> THIS IS AVAILABLE IN ARCHITECTURE
 From:L25 <psu201435> THIS SERIES IS KEPT ON RESERVE IN ARCHITECTURE,
 > VOL.1-13
 From:L25 <psu198320> THE FOLLOWING ARE ON RESERVE IN ARCH: 1st copy 1,
 > 2nd,3rd v.1c.1 and
 > also on reserve in arch: 3rd v.2c.1, 4th v.1c.2, 5th
 > v.1,2,3-5,6-8,9-10,11-12, 7th bk.1, 12th,13th,14th
 From:L25 <R3001590> THIS IS AVAILABLE IN ARCHITECTURE
 From:L25 <R3001570> VOL.16 IS AVAILABLE IN ARCHITECTURE
 From:L25 <70649723> THERE SHOULD BE A SPACE BETWEEN THE VOL. & DATE;
 > ALSO ALL ARE AVAILABLE
 > ALL ARE AVAILABLE IN ARCHITECTURE REFERENCE
 > COLLECTION
 From:L25 <R1015602> THERE IS ALSO A COPY AVAILABLE IN ARCHITECTURE
 From:L25 <osu291862> THERE SHOULD BE A SPACE BETWEEN THE VOL. & DATE;
 > ALSO IS AVAILABLE IN ARCHITECTURE
 From:L25 <sc81006042> NUMBER 6 IS ALSO AVAILABLE IN ARCHITECTURE
 From:RES <62017516> THE CALL NUMBER FOR ITEM 8599964 SHOULD BE
 > RF723.M4M45
 From:ART <56026188> WORD AFTER "ZION" IN TITLE SHOULD BE SPELLED
 > "CHURCH", NOT "CHURCY".
 From:AAH <53000652> check 250 field
 From:MIC <psu292269> the dates of the microform holdings are incorrect;
 > it should be 1821-1888
 > the dates for the microform holdings are incorrect.
 > it should be 1901-1994; 1906-1992
 From:LFS <osu194495> CALL NUMBER IS 409275.D3 AND WE KEEP 2 YEARS ONLY
 From:NMC <psu105138> ck sp of certain in the title
 From:NMC <psu231433> ck sp of exponent in the title
 From:JAG <R2012036> 090 field needs the parenthese) deleted
 > 070 field word misspelled (Halstead) should be
 > Halsted
 From:JAG <80025153> 245 field has wrong indicator should be 00
 From: <psu128681> 650?
 From: <psu126483> 650?
 From: <osu126649> 609#?

Some guidelines for completing the error report form are as follows:

1. Fill in the correct call number of the item (A)
2. Fill in the DATE SENT area (B)
FROM
3. Fill in SULIRS control number (use one form for each number that has an error) (C)
4. Fill in the field containing the error (D)
5. Indicate what is wrong with the field (E)

Then, if

I. The item is cataloged

- A. Only the SULIRS record needs correcting (that is, the catalog cards match the item)

Attach:

1. A SULIRS printout of the record in working mode

- B. The SULIRS record and the catalog cards need correcting:

Attach:

1. A SULIRS printout of the record in working mode
2. A photocopy of the title page or the book itself which indicates the correct information.

II. The item is uncataloged

Attach:

1. A SULIRS printout of the record in working mode
2. A photocopy of the title page or the book itself

It is especially important to provide clear information as to the nature of the problem. If necessary, use the back of the form to explain

Where you feel the book itself is incorrectly cataloged but the SULIRS record and/or catalog cards are correct, please use the pink Cataloging transmittal form to send the book to Cataloging and indicate the nature of the problem.

SYRACUSE UNIVERSITY
LIBRARIES
TECHNICAL SERVICES
SULIRS ERROR REPORT

Call Number

A

DATE SENT B

FROM (Dept., Name, Extension):
B

TO: CATALOGING

SULIRS CONTROL NUMBER C

FIELD CONTAINING ERROR D

ERROR E

- ITEM IS CATALOGED
- SULIRS RECORD ONLY NEEDS CORRECTING

ATTACH:

1. SULIRS printout of record in working mode

- SULIRS RECORD AND CATALOG CARDS NEED CORRECTING

ATTACH:

1. SULIRS printout of record in working mode.
2. Photocopy of title page or book itself.

- ITEM IS UNCATALOGED

ATTACH:

1. SULIRS printout of record in working mode.
2. Photocopy of title page or book itself.

BEST COPY AVAILABLE

SYRACUSE UNIVERSITY LIBRARIES

III. Authority work at SUL

Prior to 1978, virtually no authority work was done at SUL. When the concept of authority control was introduced, we did not choose the more conventional, rigorous, and labor-intensive method of a full pre-cataloging authority search and authority file development practiced by most large research libraries. This would have involved checking all names encountered in all cataloging records (both LC and member OCLC records) against the local authority file and, for each name not found in the file, creating an authority card complete with cross-references. Some libraries follow similar procedures for subject headings as well.

Instead of following this approach, we elected to rely mainly on a post-cataloging edit as the foundation of our authority procedures. All LC cataloging (which is used for approximately 92% of the cataloging currently done by this department) is accepted with no authority search prior to or during cataloging. All member input cataloging is subjected to a thorough authority search before cataloging because these records contain a significantly higher proportion of error than do LC records and because the subject access provided by these records is often inadequate or inappropriate.

The better quality of LC records makes it much more efficient to rely on a post-cataloging check of new names and subjects only and to recatalog when necessary than to check 100% of all names and subject headings prior to cataloging. With OCLC member input cataloging, the opposite is true: it is more efficient to revise records prior to cataloging than to rely on a post-cataloging edit because the latter would result in a tremendous increase in the amount of recataloging that would need to be done.

SYRACUSE UNIVERSITY LIBRARIES

Revision of OCLC member input records involves the following steps - all performed by a catalog librarian - and is crucial if we are to maintain quality control in cataloging:

- a. verifying or assigning an LC call number, using the LC classification schedules and checking our shelflist
- b. verifying that all name entries are consistent with LC forms of entry, using the LC Name Authority File and LC records in the OCLC data base.
- c. verifying or assigning LC subject headings that are both legitimate and appropriate to the item, using Library of Congress Subject Headings.
- d. making a new series decision, if necessary.
- e. checking the descriptive cataloging and adding notes, etc., as appropriate.

The post-cataloging edit of LC cataloging involves the following:

In 1983, a local computer resident subject authority file was created which allows us to identify by program all new subject headings being added to SULIRS. New subject headings are checked in Library of Congress Subject Headings by cataloging staff to determine if they are legitimate headings or not, and catalog librarians authorize the recataloging of those records that contain significant subject heading errors.

A computer resident name authority file that allows us to automatically identify new names being added to SULIRS from our OCLC archive tapes was created in 1984. Cataloging staff check all new names in the LC Name Authority File. Catalog librarians determine which headings are erroneous and need to be corrected by recataloging through OCLC. It is through our name authority work that we identify names that have changes significantly under AACR2 so that invisible linkages can be created in SULIRS between the AACR2 and pre-AACR2 forms.

As a result of this post-cataloging edit, the Catalog Department corrects approximately 1200 significant errors (i.e., errors that render SULIRS records irretrievable) in name entries and subject headings per year. Eliminating our authority control procedures would lead to a rapid deterioration in the quality of the SULIRS data base.

SYRACUSE UNIVERSITY LIBRARIES

Authority control in an on-line environment is different than it was when we were filing cards in the card catalog, but it is still necessary. For example, word order was extremely important in the card catalog whereas, with the key word searching available in SULIRS, it is insignificant. On the other hand, with the card catalog it did not particularly matter if a word ^{in a heading} was singular or plural, one word or two words hyphenated, or had an apostrophe imbedded in it or not; patrons could thumb through catalog cards until they found what they were looking for. In SULIRS, however, these kinds of problems and minor misspellings render SULIRS records irretrievable. It doesn't matter how sophisticated a retrieval system is; poor data in a data base will adversely affect the reliability and public acceptance of the on-line catalog. The assistance that the computer can provide in helping to maintain a high quality catalog is limited (it can identify certain types of diagnostic errors, such as required data that is missing). But quality control of the intellectual content of catalog records is largely dependent on our willingness to commit some of our very limited human resources to the effort of authority control and revision.

SYRACUSE UNIVERSITY LIBRARIES

LMFCLN

A. Cleanup activities to be performed in August, 1984 (arranged approximately in the order in which they are performed in the program):

CHANGE SPECIFICATIONS

1. Branch loan code changes:
 - a. * Status code/fund code '7Z' (zoology) is obsolete. Change both status code and fund code to '7B' (biology) if both status code and fund code are '7Z'.
 - b. * Records with branch loan code or fund code of '9A' or '1A' are internal items. Change all the occurrences of status code/branch loan code '1A' to '9A' (to be consistent). This should be done next year as well.
 - c. * Print records with a branch loan code of '6A'. Some of these must be changed to '6I' by recataloging them.
printout (e. Acct.?)
2. Put blanks in unused positions of the 'A' field (this is to clear out fields that are no longer used).
3. Replace any invalid origin codes with a blank. The only allowable values are 'M' (MTST), 'D' (Dayton), 'O' (OCLC), 'C' (90 million circulation records), and blank (all other records processed since July 1, 1971).
4. Substitute the control number for any set numbers with value zero. Past errors have caused this condition. Control numbers and set numbers are usually the same except for multiple pieces and serial details.
5. Replace set number 7999996 in dummy MOA records with the control number value. Set number was assigned in this range as part of an effort to avoid generating accounting records for dummy records.
6. Audit and possibly reassign the accounting record type sub-field. If other than 'L', 'M', 'F', 'S', or 'T', then assign 'L' for records with control numbers between 10 million and 30 million and assign 'T' for all other records. Past errors have caused a blank to be put in into this field which is an error.
7. Status code changes:
 - a. * Some OCLC locked records have been erroneously given status codes that are less than 15 (cataloged no invoice) and not 9 (deleted). Change these status codes as follows:

BEST COPY AVAILABLE

SYRACUSE UNIVERSITY LIBRARIES

LMFCLN

If status code is 12 (invoice no book), 13 (invoice partial receipt) or 14 (invoice full receipt) then change it to 16 (cataloged with invoice).
Otherwise change status code to 15 (cataloged no invoice)

- b. Print any recieved record (status code 10, 11, 13, or 14) that has a valid call number and has been circulated. *printout to Cat Dept.* *
 - c. * Change all occurrences of status code 22 (lost) to 7 (library cancellation). An unknown serie set the status code of many records to 22.
 - d. Find invalid status codes. For received items only (items with non-zero location numbers), correct the status code as follows: if a call number is present, then assign status code 15 (formerly assigned 16). Otherwise, assign status code 11 (formerly assigned 14).
8. ✓ Print incomplete dummy records, i.e. records with any one of, but not all of, the following: *printout to Cat Dept*
- '>T.1 *T'
 - '>M.1 *M'
 - '>I *I'
- Incomplete dummies are caused when an inputter forgets to change a field or by program error.
9. * Eliminate the main entry (M1) if it duplicates the title (T1). Eliminate the series title (S1) if it duplicates T1. Do this for cataloged, non-dummy records only. *why only non-dummy records?*
10. Replace any lower case characters found in textual fields with their upper case equivalents. Eliminate any escape codes which are present in these fields. (Look specifically for a hexadecimal value '27', and delete it and the one character which immediately follows.)
- Eliminate all unprintable characters, i.e. characters below hex '40' and characters above hex 'F9' but below hex 'FF'.
- Print before and after versions of these records so that they may be checked out by Computing Services Personnel. These printouts will not be sent to the library, unless specifically requested.
11. Call number field changes:
- a. If a record has status code 15 or 16 (cataloged and is not a dummy) but lacks a call number then insert '**CALL# MISSING' in the call number field.
 - b. Remove any leading blanks from the *318A UVA-YC-1127P* call number field.

SYRACUSE UNIVERSITY LIBRARIES

- c. * Print cataloged records (status code 15 or 16) that do not have science or reference branch loan codes and that have call numbers that do not match their branch loan codes. This will allow Library staff to check for bad 049 fields. *Printout to Circ. Dept.* *
- d. * Reformat media call numbers as follows:
- i. Change occurrences of "FILM" to "MICROFILM" (be sure not to change occurrences of "FILMSTRIP" to "MICROFILMSTRIP").
 - ii. An OCLC program error resulted in some media words lacking a trailing blank. This program error has been corrected. Insert a blank after the following media words if none exists:
FILMSTRIP, MEDIA SET, MICROFICHE, MICROFILM, PHONODISC, PHONOTAPE, and VIDEOCASSETTE.

12. >E field changes.

- a. Remove E fields from records in the 30 million range. These E fields were generated for dummy records to avoid generation of accounting records.
- b. * Serials staff get confused when they see the word "DUMMY" in the >E field. Change "DUMMY" to " " .

13. Delete unwanted portions of the working notes (W) field in records with status codes 15 through 18, as follows:

- a. if the first 2 characters of the field are "CC", leave the field alone.
- b. remove any semi-colon and the text which follows. This will remove old order/receipt information.

14. Compile fund code and branch loan code statistics for items processed in the last fiscal year.

BEST COPY AVAILABLE

REMOVAL SPECIFICATIONS

Dummy records and records that have circulated within the last 12 months (from the run date) will not be removed.

15. Remove from the LMF any received record (status code 10, 11, 13, or 14) over 5 years old which is not in the 5 million

SYRACUSE UNIVERSITY LIBRARIES

LMFCLN

through 8 million range and is now a law record (and has no call number??). Print those records which are not removed because of recent circulation activity. *and print out to Cat. Dept.*

16. Remove from the LMF any cancelled, deleted or withdrawn records (status codes 7, 8, 9, or 23) that have an order/receipt date subsequent to 1 year before the run date. Print those records which are not removed because of recent circulation activity. *print out to Cat. Dept.*

17. Handle records with '**CALL# MISSING' in the call number field as follows:

If the record is OCLC locked and the status code is 15 or 16 (cataloged) then print the record. *to Cat. Dept.*

If the record is not in the 5-8 million range and it is not a law record (branch loan code of '8L') and the order receipt date is not within the last 12 months from the run date then remove the record (Print those records not removed because of recent circulation activity). *print out to Cat. Dept.*

18. Remove from the LMF (place on the deletes file) any phono disc records with status code that indicates the invoice is received (14, 16, 18 or higher). Remove only those records which have fund code '2M' and branch loan code '2M' and marc type 'J'.

19. Remove poor quality records as follows:

Remove from the LMF any non-OCLC, non-law record that has a control number less than 5 million or has an origin code of 'D' or 'M' (Dayton or MTST). These are old system records that have incomplete data. (will not be removed because it has circulated in last 12 months)
 * Remove all 90 millions (only those that have not circulated within the last 12 months will really be removed).

20. Any record removed from the file will have the working notes (W) field modified with the date (YYMMDD), who, why, and reason why in the format:

YYMMDD, who, why
 where the 'who' field will contain the program name 'LMFCLN', and the 'why' field will be one of the followings:
 'OLD RECEIVED', 'LIB CANCEL', 'VENDOR CANCEL',
 'DELETE', 'WITHDRAWN', 'CALL # MISSING',
 'PHONO DISC', 'D M OR <5M', or '90 million'.

BEST COPY AVAILABLE

IX. DATABASE MAINTENANCE AND SECURITYUpdate

1. The system should include the capability of both online and batched updating.
2. The ability to update in batch mode mandates the capacity to save records.
3. Frequency of update should vary according to source of material. OCLC tapes should be loaded weekly; added copies, volumes, transfers, lost and withdrawn materials should be batched for over-night update. Indexes to records should be updated once in each 24-hour period. However, the system design must not preclude the possibility of real-time updates and changes to the database.
4. Corrected records should be compared with the authority files and a printout of conflicts generated daily.
5. The capacity to produce global changes should be provided through the authority control system. All headings in the bibliographic records should be linked to authority records to provide for automatic updating to maintain consistency with the authoritative form of the name or subject heading.

Adding Records

1. New records added to the database should be checked against the authority files and the headings automatically changed to the authorized forms.
2. New headings not already represented in the authority file should be added to the file and a daily printout of these headings generated.

Security

1. Passwords should not be needed to restrict the basic bibliographic information; it should be available to all users. However, in the case of some information pertaining to rare items or special collections, or when circulation and acquisitions functions are added to the system, passwords would be needed for some types of access.
2. Protection of the data is of utmost importance, and prevention of unauthorized manipulation should be built into the system. In order to add, delete, or alter records, passwords and a key to change a terminal from a "public" to an "input" mode should be required.

Backup

1. A duplicate computer file on tape stored at a non-library location is the preferred backup system. The entire database must be copied periodically and all maintenance transactions logged daily so that the database can be reconstructed in case of system malfunction.
2. Safeguards should be provided to prevent loss of information during system failure. The recovery program should pinpoint the moment of interruption and allow completion of the update of the records in process at the time of the failure.

BEST COPY AVAILABLE

50

44

Duke University

Durham
North Carolina 27706

William R. Perkins Library

May 13, 1985

Gillian M. McCombs
State University of New York
at Albany
Technical Services
Library B35A
1400 Washington Avenue
Albany, New York 12222

Dear Gillian:

I have enclosed several documents which I hope will be of interest. Let me explain them by first giving a brief outline of our evolution toward online catalog maintenance.

Brief Chronology

1979 -- began using OCLC

A commitment was made at this time to keep our OCLC archive tape records up-to-date with bibliographic changes. For monographs, we also established the policy of maintaining up-to-date holdings information through OCLC. Since there was no adequate holdings field for serials, these have been kept in separate manual records.

1980 -- as a member of the Triangle Research Library Network (TRLN) we began receiving "Exceptions Reports."

TRLN uses our archive tapes to create a local database which will be the foundation of our online catalog. As part of the activity of creating the database, OCLC archive tape records are processed to deal with duplicates, to correct certain errors, and to flag other errors or potential problems. These are printed out as "Exceptions Reports." One of our catalog maintenance activities is to correct the errors, etc. that are detected.

TRLN comprises the libraries of the University of North Carolina at Chapel Hill, North Carolina State University, and Duke University. We are working together to develop an online, integrated system. The current phase of development is testing the online catalog and online catalog maintenance system that will be brought up beginning this fall.

May 13, 1985

1982 -- TRLN brings up the Online Editing System (OES).

OES is an interactive, online editing system which gives access to our local OCLC records. OES is the database created by TRLN that I described above. We use OES to make corrections and changes to bibliographic records where new cards are not needed. We also use it to keep our holdings for monographic records up-to-date.

1985-86 -- TRLN will bring up the Bibliographic Information System (BIS).

BIS will be an online catalog and online maintenance system.

Documents Enclosed

1. Online Editing System, Recommendations
2. OES Corrections Chart
3. TRLN Exceptions Report Priority Chart

The above are three planning documents that came out of the committee charged with OES implementation.

4. The TRLN Online Editing System: User Information

This is the OES manual produced by TRLN.

5. TRLN Bibliographic Information System: Technical User Manual

This is the manual we will use when the BIS system for online catalog maintenance comes up. We are now testing this system.

I have not included any job descriptions or local procedures. Since we are in the transition phase of supporting both manual and online catalog management, the jobs in catalog management as well as the local procedures we follow are bound-up in the manual activities more than in the online activities. This is because manual activities require so much more work and attention.

There are several other TRLN documents that are available which describe the processes by which records being added to our local data base from OCLC archive tapes are "validated." This is the process of dealing with duplicates and checking for errors or problems. Also, as records are worked on online through BIS, they will go through a validation process. This is also described in TRLN documentation. I have not included these documents since I didn't think they would be particularly helpful, but if you wish to have copies you can contact me.

May 13, 1985

As we have evolved from a totally manual system toward an online system, each step has brought numerous changes in policies, procedures, workflow, organization, and staffing. We have had a general policy of carefully planning for the changes, reviewing and analyzing the current process, and seeking ways to integrate the new processes most effectively. There were many committees to deal with each phase of development and there has been a great deal of documentation along the way. The items I have enclosed are representative. Our careful planning and documentation have paid off, for our testing of the online catalog thus far developed shows that our database, maintained so carefully, is a strong foundation for the system.

Thank-you for your interest in our activity.

Sincerely,



Jaye Bausser
Head, Post Cataloging
Operations Section

Reader Note: the documents
listed in this section are
available from the SPEC office



THE UNIVERSITY LIBRARY

Reader Note: the documents
listed in this section are
available from the SPEC office

UNIVERSITY OF CALIFORNIA
LOS ANGELES, CALIFORNIA 90024

June 13, 1985

Gillian M. McCombs
Technical Services (CASM)
University Library
State University of New York
at Albany
1400 Washington Ave.
Albany, NY 12222

Dear Gillian,

I have received permission from the UCLA Library Administration to send you the enclosed materials on ORION. You may include them in the SPEC kit if you find them relevant. Let me briefly describe them to you.

Editing Documents

TPS Document E1A

This document describes the keyboard of the IBM 3101 terminal. The document was written in 1981 when the system was called "TPS" (for Technical Processing System).

TPS Document E2A

This document describes the process of updating a record on ORION, using an IBM 3101 terminal. All processing staff, whether doing catalog maintenance work or some other processing activity such as serials check-in, are taught this basic process.

ORION Document E1C

In 1985, we began installing IBM synchronous terminals, the 3178 and 3180. This document describes the keyboard.

ORION Document E2C

Describes the updating process, using one of the synchronous terminals.

ORION Document E3

Describes how new records are added to the database by staff. Most cataloging records are created on OCLC and then loaded into the ORION database. Only materials receiving less-than-full cataloging treatment have records input directly by cataloging staff into ORION.

Introductory Documents

Introduction to the
ORION Browse Command

This document gives some information about the linked subject authority file and how it is searched. It was written in 1983. ORION staff are currently working on the design and programs for the linked name/series authority file which will be similar to the subject authority file. In addition, some improvements will be made to the subject authority file.

Introduction to the
Serials Module

This document will give you an overview of the serials module. Please note that the local, processing information (for example, volume/issue specific holdings, payments, credits, vendor, notes, etc.) is the responsibility of the branch library. The "branched" fields are attached to the cataloging record, the latter being the responsibility of one of the four cataloging departments on campus.

Introduction to the
Monograph Acquisitions
Module

Again, local processing information is attached to the bibliographic record. However, these bibliographic records are not cataloging records; they are brief records input by acquisitions staff. The cataloging staff will change a main entry if, for instance, they see that the form of name is incorrect. Names and series from acquisition records will be included in the linked name/series authority files. If a heading from an acquisitions record is unique, it will be labeled as a provisional authority record so that staff will know that it is not authoritative.

I hope that this documentation will give you enough background about ORION for you to be able to make sense of our answers to your telephone survey questions.

In regard to your question on VDT use, there was an informal survey done several years ago by a member of the Library Administrative Staff. Gloria Werner, our Associate University Librarian for Technical Services, tells me that the important recommendation from this survey was that the Library purchase comfortable and easily-adjusted terminal chairs for staff, particularly in departments where terminals were shared by a number of people of varying heights. As a result, the Library buys as many new chairs as it can each year and parcels them out as fairly as possible. I should add that all terminals have glare screens at the time they are installed.

Josephine Crawford
Josephine Crawford

May 16, 1983

INTRODUCTION TO THE CRION BROWSE COMMAND

I. DEFINITIONS

Bibliographic record

The record for a particular item or work held by the Library or in some state of acquisition. The monographic and serial cataloging records and in-process records from the ORION MC, IP, TC, and BS files are all bibliographic records.

Authority record

The authority record gives the established form of name which should be used when that name is a heading (main or added entry, uniform title, series, or subject) on a bibliographic record. In addition to the established form of the name, the authority record contains cross references for alternative forms of that name, if there are any.

II. DEFINITION OF THE BROWSE FUNCTION

The BROWSE command is designed to allow for more exactness and greater ease of searching subjects, names, and series in ORION. Use of the BROWSE command involves searching all of the headings that contain a given search term(s). The BROWSE command is different from the F NT or the F SU search, in which keywords are searched in the bibliographic records. BROWSE involves searching keywords in the browse / authority files.

When the BROWSE command is used, the user is actually searching the dictionary (or index) of one of the authority files. These authority files consist of authority records for all of the names, series and subjects used in the CRION database. The authority files are maintained by the cataloging centers and are used to insure the consistency of headings across all ORION files. The authority files also allow the ability to change the heading on an authority record and to proliferate that change to all of the related bibliographic records.

Currently, only the BROWSE SUBJECT authority file is available. There are plans to expand the BROWSE capability to names and series, and possibly call numbers.

III. SPECIAL FEATURES OF THE BROWSE COMMAND

There are a number of important features and enhancements to remember when using the BROWSE feature.

BEST COPY AVAILABLE

BROWSE COMMAND

1. Regardless of file setting or authorization code, users are able to search the browse files. If the retrieve command pulls up records from a bibliographic file not included in the file setting, the records will still display. The system will recognize that file and users may roll forward (RF) and roll backward (RB) from that record. In contrast, in a FIND search (F NT or F SU) users only search the dictionaries of the files according to the file setting.
2. Bibliographic records retrieved with the BROWSE command will be displayed in one alphabetical sequence even though the records are retrieved from different files. This means that serials and monographs will be interfiled.
3. In the authority file, each heading is considered a record. This means that the terms in the search request must appear in the record (heading) in order to be considered as a "hit". In this sense, the BROWSE command allows for field searching. In contrast, when multiple search terms are used in the FIND SU search, a bibliographic record may be retrieved because one of the search terms appears in one subject heading field, and one appears in another.
4. The BROWSE command uses all of the other ORION searching capabilities, such as Boolean logic, truncation, etc.
5. It is not possible to combine a BROWSE search with another index search type, such as FIND NT. To do a combined author - subject search, use the FIND NT and the FIND SU command form.
6. A number of new commands have been defined for use with the BROWSE function and appear in Section V. below. These commands also appear in the "OPTIONS" at the bottom of each screen retrieved while using the BROWSE command.
7. A new feature will soon be added to the BROWSE command which will eliminate a number of the current problems with terms on the stoplist, or which appear too often in the ORION database. If any term in the search request appears less than 4,000 times in the browse file dictionary, ORION will proceed with the search. If all of the terms in the search request appear over 4,000 times, the search will still be stopped. This is the first phase in eliminating the stoplist.

IV. SEARCHING WITH THE ORION BROWSE COMMAND

To initiate a "BROWSE" search, enter the command:

BROWSE SU _____ (where _____ are your search terms)

EXAMPLE: BROWSE SU CIVIL WAR

BEST COPY AVAILABLE

57

BEST COPY AVAILABLE

BROWSE COMMAND

ORION will respond with a brief list of all of the subject headings that match that search request, in alphabetical order across all bibliographic files. This brief list display will number the subject headings (or name headings, etc., as the case may be) so that they can be used with the retrieve command. The number of online ORION records will appear next, followed by the heading. Cross references will also appear on this brief listing in the form, for example: See, Holy SEE Holy See. The see references will be interfiled alphabetically among the headings. The current search and the number of results will appear at the top of the list and the options for the user's next step will appear at the bottom of the screen. For example:

CURRENT SEARCH: BROWSE SU CIVIL WAR

-SUBJECT HEADINGS CONTAINING ENTERED BROWSE TERM(S) - 220 RESULTS.

<-> NUMBER OF ONLINE ORION RECORDS CONTAINED IN EACH GROUP.

R1	1	Alabama--Politics and government--Civil War, 1861-1865.
R2	1	Angola--History--Civil War, 1875--Participation; Cuban.
R3	1	Arkansas--Politics and government--Civil War, 1861-1865.
R4	1	California--History--Civil War, 1861-1865.
R5	3	Cambodia--History--Civil War, 1970-1975.
R6	1	Cambodia--History--Civil War, 1970-1975--Addresses, essays, lectures.
R7	2	Charleston, S.C.--History--Civil War, 1861-1865--Sources.
R8	7	China--History--Civil War--1945-1949.
R9	1	China--History--Civil War--1945-1949--Drama.
R10	1	China--History--Civil War--1945-1949--Fiction.
R11	1	Civil War.
R12	1	Civil War--Case studies.

*OPTIONS: -TYPE R1 (OR R2, R3 ...) TO RETRIEVE THE RECORD(S) IN A GROUP.
-PRESS THE ENTER OR RETURN KEY TO SEE MORE OF THE LIST.
-BEGIN A NEW SEARCH (E.G. FIN NI ..., OR B SU ...)

ENTER NEXT COMMAND

The user may then use the command RETRIEVE and an index number; this will trigger a search on the external record numbers attached to the browse record, thus retrieving all of the records in ORION which have that subject heading.

At the top of the screen on each bibliographic record will appear information to help users keep their place in the search. "Group _ of _" identifies which heading is being reviewed (out of all of the headings retrieved by the search). The heading of that group is also displayed; for example, "GROUP: Alabama--Politics and government--Civil War, 1861-1865." The notes "RECORD _ OF _", and "SCREEN _ OF _" will also appear at the top of the bibliographic record. For example:

BEST COPY AVAILABLE

3184 JAVVA YACU 1 1988

58

BROWSE COMMAND

CURRENT SEARCH: BROWSE SU CIVIL WAR
GROUP 1 OF 220 ; GROUP: Alabama--Politics and government--Civil War,
1861-1865.

RECORD 1 OF 1

Smith, William Russell, 1815-1896.

The history and debates of the Convention of the people of Alabama : begun and held in the city of Montgomery, on the seventh day of January, 1861 : in which is preserved the speeches of the secret sessions, and many valuable state papers / by William R. Smith. Spartanburg, S.C. : Reprint Co., 1975. <0234250MC> 464, xii p. ; 22 cm.

SUBJECT(S): Secession.

Alabama--Politics and government--Civil War, 1861- 1865.

URL JK 9778 A15 1861

*OPTIONS -TYPE D1 (or D2, D3 ...) TO SEE ANOTHER RECORD FROM THE LIST.
-TYPE DISPLAY TO RETURN TO THIS TITLE LIST.
-TYPE RE - REDISPLAY HEADING LIST; NG - NEXT GROUP; PG - PREVIOUS GROUP.
-BEGIN A NEW SEARCH (E.G. FIN NT ... or BROWSE SU ...)

ENTER NEXT COMMAND

Possible options and commands appear at the bottom of the screen following the bibliographic record when the record display is set to the reference or public display (SET 9).

Currently, authority records exist online for bibliographic items which are not represented in ORION, such as non-Roman materials. The headings will still appear in the browse / authority files. If they appear on a heading display, a "0" will display next to the heading for the number of online records. Since these records will not have any bibliographic record numbers attached, if a user tries to retrieve records with that heading, the following message, or a similar message, will appear:

The heading : _____ does not appear on any online ORION records. However, materials under that heading may appear in the public card catalogs. Please check there, or ask a library staff member for assistance.

V. COMMANDS

Several new commands have been designed for use with the browse search. The commands and their use appear on the next page.

BEST COPY AVAILABLE

BEST COPY AVAILABLE

BROWSE COMMAND

BROWSE SU (or HSU or B SU)

This is the syntax for searching subjects with the browse command.

RETRIEVE # (or R#)

Once a browse search has retrieved a list of headings, the command R# may be used to initiate a search to retrieve the bibliographic records that are linked to the heading. Replace the pound sign (#) with the number which appears next to the "R".

UP

This command may be used to make the brief heading list scroll up; if the first heading displayed on the screen is R20, the UP command will cause the headings previous to R20 to display, beginning with about R15.

RE

The "return" command may be used to return to the headings list from either a bibliographic record or from a brief title list of bibliographic records. For example, if a record in Group 10 is being displayed, the command RE will return to the heading list beginning with R10.

NG

The "next group" command may be used from either the brief title display or from a bibliographic record display to go to the next group, following the group currently being displayed.

PG

The "previous group" command may be used from either the brief title display or from a bibliographic record display to go to the previous group, preceding the group currently being displayed.

NR

The "next record" command may be used to display the next record in the heading group currently being displayed.

PR

The "previous record" command may be used to display the previous record in the heading group currently being displayed.

D#

The "display" command may be used in two ways. First, when the command D# is used from the brief headings list, it will display the actual authority record for that heading. Public users will see the authority records in the reference display format and staff will see the records according to their display setting. The commands fl, marc, pub and ref are valid for staff members. Second, when the command is used from a brief title list, it will display the appropriate bibliographic record.

VI. LINKED AUTHORITY CONTROL

As mentioned above, the BROWSE command is used to search the dictionary of one of the authority files. The authority files may also be considered as working files for the cataloging and acquisitions staff. The format of the records in the authority files is based upon the MARC format for Authorities which is distributed by the Library of Congress. A few local fields have been added to the format for the purpose of recording whether the heading is used in the monographic and/or serials bibliographic files, and to maintain the link to the bibliographic records.

In the ORION authority files, the following fields are used:

- 008 - Fixed field
- 1XX - Established heading
- 4XX - See reference leading to the 1XX
- 5XX - See also reference
- 6XX - Notes
- 1011 - Local field for recording the record numbers of the bibliographic records linked to that authority record.
- 035 - Local field for recording whether the heading is used in the monographic or serial file, or both.

Sample Subject Authority Record

CURRENT SEARCH: BROWSE SU CIVIL WAR
RECORD 1 OF 220

PV.....(0007662 H2:B21)

<00>151-0 _0\$uAlabama\$xPolitics and government\$yCivil War, 1861-1865.

<00>1011 SMIN502J4250

Headings will be added to the authority files at the time a new bibliographic record is added to ORION, either from an incoming OCLC tape or from a record keyed directly into the database. All incoming headings will be matched against the headings in the authority files; headings which conflict will appear on regular edit lists. Whenever a bibliographic record is updated, ORION will automatically update the authority record.

Cross references and notes will be added to the authority records by direct keying.

BEST COPY AVAILABLE

TEMPLATES

Certain ORION records are designated as "template" records. Templates are, in a sense, dummy records which have several unique characteristics (described below) and which may be used as workforms for inputting data into the ORION files. Using templates reduces considerably the amount of keying required to enter new records and, even more importantly, reduces the potential of keying errors. In essence, a template is a record out of which new records may be created.

The ORION User Services office (OUS) sets up permanent templates for each unit. Staff may then modify or expand the templates as necessary to allow for individual needs. These templates contain the basic field tags, indicators, and subfield delimiters as well as local processing data which are common to all or the majority of new records input by that unit. This data then does not need to be keyed for each individual record. Templates may be specific or general in nature. For example, a large unit may create ordering templates for each heavily-used vendor, while a smaller unit may simply require one general template for purchases.

Here is an example of a template. This is from the IP file, and is used to enter new order records for monographs.

```
.PV.....(000524 11:IPT)
SN..9999999
<00>008-0 LN/ENG,CT/US
<00>010-0 __$a
<00>020-1 __$a
<00>100-0 __$a
<00>245-0 __$aEP ACADEMIC BOOK CENTER ORDER TEMPLATE
<00>260-0 __$a
<00>400-1 __$a

<EP>905-1 ZVACB,ACQP,MA/UR,SB1
<EP>906-1 -
<EP>907-1 PD/LBBH02
<EP>945-1 $a
```

62

TEMPLATES

ORION User Services keeps a master record of all templates in the ORION files and the departments to which they are assigned. If your unit needs additional templates, contact the OUS office. OUS reserves a sequence of low record numbers in each of the files so that these numbers can be assigned to template records. This simplifies your keying -- it is easier to type 100 rather than 104389 whenever you need a template!

It is important to remember the following points in connection with the use of templates:

1. Templates have a record status of "T". The status code displays after the file name at the end of the PV line. Templates also contain a line below the PV line consisting of the characters SN..9999999. The SN line instructs the system to assign a new external record number to the data input and therefore to create a new record rather than modifying the existing record (i.e. the template itself).

```
\PV.....(0000223 I1:IPT)
  SN..9999999
```

2. Like other records in the system, templates have both record numbers (internal and external) as well as a filing prefix. Therefore they must contain some data in the 245 (Title) field by which the record can be filed alphabetically in the online files. The "title" for template records should consist of a phrase that indicates the nature of the template (e.g. "Blanket template, Art Library - Blackwell"). If this practice is followed, templates may be searched by relevant keywords if the external record number is not known.

The title field should contain the word "template" so that ORION staff can search on that word and be sure of retrieving all templates. In addition, the title should include a designation of the branch or department to whom the template belongs (either a branch code or the spelled-out name). (An exception to this last rule is that the large UML departments like acquisitions or control have not been required to include the department name in the past.)

3. When you enter data on a template to create a new record, it is important to transmit the SN line, as well as any fields that you want to add to your new record.

TEMPLATES

4. After data from a template is transmitted and then reformatted by the computer for proofreading, the external record number of the new record is displayed on the PV line as "9999999" and the SN line is no longer present. The 9's are a placeholder and are a signal to you that a new record will be added to the file after you OK the record. When you have completed your modifications and issued the OK command, the system assigns permanent internal and external record numbers. These numbers will be displayed to you in a message at the top of the screen (e.g. "0099437 (TC-000209386) ADDED AS NEW RECORD TO THE 'TC' FILE.")
5. Any record may temporarily be used as a template by simply inserting an SN line below the PV line. This is useful if you need to enter a record that is very similar to a record that already exists in the file. For example, a record for a first edition of a title may exist and you may need to order the second edition. By basing your new order record on the existing one, you can save keying time, since much of the bibliographic information will be the same for the two editions.

The SN line should be inserted exactly as it appears in the example above. There are two ways to add the SN line. If your terminal has an "insert line" key, you may use that key to add a blank line below the PV line, in which the SN line can be keyed. Some terminals (such as the IBM 3180) do not have an "insert line" key, so there is also a **TEMPLATE** command, which will automatically insert the SN line for you in the proper format. The command may be abbreviated to **TEN**. The **TEMPLATE** command is available on all types of terminals.

After inserting the SN line, be sure to change the appropriate bibliographic and processing fields to fit the new title being added to the file.

6. In order to change the template record itself (rather than using the template to create a new record), you must erase the "SN..9999999" line from the screen display. Without the SN line, the template record itself can be edited just like any other record. Note that the SN line will reappear when the record reformats. Simply issue the OK command; it is not necessary to erase the SN line again. You can tell that the template record is being modified because the original record number remains on the PV line. If a new record were being added from the template, 9999999 would have been inserted on the PV line. This is a good way to keep track of whether you are modifying the template or adding a new record.

BEST COPY AVAILABLE

338 MAY 1964 251
64

TEMPLATES

7. Unlike other records, templates are not enqueued. That is, they are not locked to other users momentarily while they are in the process of being updated. Therefore, more than one user at a time may use the same template for the creation of new records.

However, this also means that you must exercise caution when updating the template record itself (by deleting the SN line). It is possible that if two users attempt to update the same template simultaneously, one of the efforts will be lost. You should determine that no one else is in the process of updating a template before beginning any changes to it.

8. Multi-screen templates: You may establish templates with more than one screen of data. However, note that when you transmit the normal SN..9999999 line, only one screen of fields (the screen you transmitted) is added into your new record. If the template contains a second screen originally, that second screen is simply disregarded.

There is a variation of the SN line that does allow multi-screen templates. This variation signals to the system that the template record should be interpreted in a different way so that all screens of data in the template are added into the new record. The alternate form of the SN line consists of the characters SN..x999999.

When an SN..x999999 line is transmitted, the process of adding a new record begins as usual -- the placeholder 9999999 is added in the PV line in the record number position. As on a single-screen template, the 9's on the PV line are your signal that a new record will be added to the file when you OK the record. However, notice that all fields (regardless of which screen they are on) are retained when the screen reformats, except those fields that you have explicitly deleted. In this regard, working with a multi-screen template is similar to updating a regular OPION record. The type of EDIT ACTIVITY message that is returned to you for a multi-screen template is more like the message given when you update a regular record than the message given when you key on a single-screen template. The message for a multi-screen template describes fields that have been deleted or modified, while the message for a single-screen template tells you all of the fields that have been added into the new record.

BEST COPY AVAILABLE

318AJIWA 00 236

TEMPLATES

Perhaps the most significant difference between one-screen templates (transmitting SN..999999) and multi-screen templates (transmitting SN..x99999) is that when you transmit SN..999999 you also have to transmit all of the fields that you want added to the new record. Any other fields on the template will be disregarded (i.e. those fields on a second screen or those fields that you have erased from the first screen). When you transmit SN..x99999 all fields in the template are added to the record, regardless of whether you have actually transmitted them. Any fields that are not needed in a particular record must be deleted (by using \$\$ or by erasing the contents of a field and leaving the tag only).

Listed below are some additional examples of templates. For guidelines in setting up processing templates, you may refer to documentation for the IP and TC files.

1. Receiving template for blanket plan (IP file)

\PV.....(000385 I1:IPT)
SN..999999
<00>008-0 LN/ENG,CT/US
<00>010-0 __\$a
<00>020-1 __\$a
<00>100-0 __\$a
<00>245-0 __\$aAUPL H S 1 BLANKET RECEIVING TEMPLATE.
<00>260-0 __\$a
<00>400-1 __\$a(

<AU>905-1 ZVHEN,ACQR,SB3
<AU>906-1 V000000
<AU>907-1 PD/SB002
<AU>946-1 \$b es \$f JSG \$u

UNAVAILABLE COPY

TEMPLATES

2. Ordering template with specialized fields for music (IP file)

```

\PV.....(000033 I1:1PT)
SN..99999999
<00>008-0 LN/N/A,CT/US,PMW
<00>010-0 __$a
<00>020-1 __$a
<00>028-1 __$a
<00>100-0 __$a
<00>240-0 __$a
<00>245-0 __$aMUSIC HARRASSOWITZ TEMPLATE - SCORE ORDERS.
<00>260-0 __$a
<00>400-1 __$a

<MU>905-1 ZVHAR,ACQP,MA/UK,SB1
<MU>906-1 -
<MU>907-1 FD/LBXX02
<MU>946-1 $
    
```

3. Receiving template for cat-as-sep^o, (IP file)

```

\PV.....(0000575 I1:1PT)
SN..99999999
<00>008-0 LN/ENG,CT/US
<00>010-0 __$a83-____
<00>020-1 __$a013048____
<00>245 0 __$aCollege cat-as-sep receiving template /
Twentieth Century series.
<00>260-0 __$aEnglewood Cliffs, NJ :$bPrentice-Hall,$cc1983.
<00>400-1 __$a(Twentieth century views)
<00>400-2 __$a(A Spectrum book)
<00>700-1 __$a

<CL>905-1 C#1-2,ZV970,ACQSC,#CU2,MA/CS,DO/CL
<CL>906-1 V000000
<CL>907-1 FD/LBCL01
<CL>946-1 $a cat-as-sep $b sp $c UK: $d ALSO IN REF $o
+OCLC-dlc $u mc,ip,af:0100o245o700
<CL>970-1 Prentice-Hall, Inc.*Box 8500 S-6025*Phlladelphia,
PA 19178
<CL>998-1 84_____ to Control
    
```

BEST COPY AVAILABLE

BEST COPY AVAILABLE

TEMPLATES

4. Template for retrospective conversion (TC file)

```

\PV.....(0000123 TC:TCT)
SN..9F99999
<00>008-0 LN/___,CT/___,PS_,RD/19___,ED/9999,R/S,ELVI,RSN,S/D,
S/L0,ST/_,T/A
<00>110-0 __$aStack Annex
<00>245-0 __$aTemplate
<00>260-0 __$aPlace :$bPublisher,$c
<00>362-1 0__$aDate.
<00>500-1 __$aNotes.
<00>690-1 _0$aSubject
<00>690-2 _1$aSubject
<00>891-0 __$a

<SX>905-1 SBZ
<SX>920-1 Call No.
<SX>930-1 HOLDINGS
    
```

5. Order template for periodicals

```

\PV.....(0000100 TC:TCT)
SN..9999999
<00>008-0 IN/___,CT/___,FO/_,RG_,PSC,BD/19___,ED/9999,A/_,B/S,
CM/_,CN/_,CPP_,C1/_,D/_,ELVK,GP/_,IA/_,ISDS,_,M/_,PM_,R/_,RSN,
S/D,S/L0,ST/_,T/A,TP/_
<00>022-1 __$a_____
<00>245-0 00$aURL serials periodicals template.
<00>260-0 00$aPlace :$bPublisher

<UR>905-1 AJNA,C#1,ZV___,OD_,#C01,MA/US,S#2
<UR>906-1 N
<UR>907-1 FD/L___01
<UR>909-1 Athzr.
<UR>930-1 ON ORDER
<UR>943-1 Faxon cust. #00936; Faxon title #
<UR>944-1 Volume and continuation
<UR>945-1 LOC:PRS
<UR>946-1 $b
<UR>963-1 Sample shelved 84_____
    
```

BEST COPY AVAILABLE

TEMPLATES

6. Template for sample issues of periodicals

```

\PV.....(0000141 TC:TCT)
SN..9999999
<00>008-0 LN/___,CT/___,FQ/_,RG_,PSC,ED/19___,ED/9999,A/_,B/S,
CM/_,CN/_,CFP_,CI/_,D/_,ELVK,GP/_,IA/_,iSDS_,M/_,PM_,R/_,RSN,
S/D,S/10,ST/_,T/A,TP/_
<00>110-0 20$aAuthor.
<00>245-0 00$aSample display template.
<00>260-0 00$aPlace :$bPublisher

<TR>905-1 SDS
<UR>938-1 IN FEBRUARY REVIEW LOT ON SAMPLE DISPLAY SHELF:
<UR>945-1 Give all issues to Serials Dept. Administrative Asst.
with record no.
    
```

7. Order template for microforms (TC file)

```

\PV.....(0000522 TC:TCT)
SN..9999999
<00>008-0 LN/ENG,CT/US,R/S,ELVK,M/B
<00>022-1 __$ai$sn-xxxx
<00>049-1 __$aCLUESvOn Order
<00>245-0 __$aKMS template - University Microfilm.
<00>260-0 __$aAnn Arbor :$bUniversity Microfilms International,

<EM>905-1 AJNH,ZVUNI,NA/RS,SB2
<EM>906-1 O_
<EM>907-1 FD/MBEM06
<EM>930-1 ON ORDER
<EM>944-1 not a subscription. Your order number:
Microfiche.
    
```

BEST COPY AVAILABLE

Northwestern
University Library
Evanston,
Illinois 60201

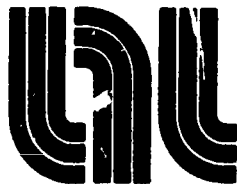

Gillian McCombs
Technical Services
Library, B35A
1400 Washington Avenue
State University of New York at Albany
Albany, NY 12222

June 6, 1985

I. Database

1. Automation planning took place so long ago (1967) that it's not clear how file maintenance was included. It was designed to be online, and remains so to this day, and is enhanced by full-screen editing which was also part of the original plans.
2. Since we control our own system design, we can plan-to-prevent, notice-at-occurrence, request-to-change, and request-mass-rectification of system induced errors. The fact that errors can be corrected immediately online, that some errors are caught by the system, and that some errors (e.g. typos in headings) show up more glaringly online than on cards adds to more and better control over the file than formerly.
3. We haven't divided errors by source. We notice errors in records transferred from tapes, in records input as provisional, and in records long since finished with. Record maintenance is accepted as part of daily routine, and we do ca. 1400 bib corrections per month. We make more corrections for the online catalog than we did for the card catalog largely because it is easy to do.
4. Tech Services is responsible for the database, and guards the responsibility jealously. Circulation may do some creation/modification of item records, but Tech Services creates

317A JAV A 7800 103E

item records for newly processed materials. Record correction is done in Tech Services, usually in Catalog by the Catalog Maintenance Section. The system is integrated (including acquisitions, cataloging, serials control, online catalog, and circulation), so data input at point of order (or receipt) and modified through the processing stream is the same data that appears in all views of the system, including circulation. It is because of the multiple users and uses of the data that we maintain such careful control. If Circ modification affected only Circulation operations we would care less.

5. Most public services terminals are "locked out" of data modification. Within Technical Services sign-on codes control which fields may be altered. We have had very little trouble with the wrong people getting hold of codes and maliciously altering records.

6. Online maintenance operations have evolved over time. At first they were a machine version of manual operations. Decisions about the quality of database maintenance were made largely by the Catalog Department, endorsed by the Alternatives to the Card Catalog Committee and the Library's Administrative Committee. All routines have been subject to reassessment as experience was gained, and/or as the system evolved. We have no vendor.

7. NOTIS (Northwestern Online Total Integrated System) is a single very integrated system.

8. Revision of catalogers' work is as difficult to fit in as always. The need for authority work is greater in the online file. The content of authority work has changed slightly, and it is more complex than before, but it is intrinsically neither easier nor more difficult. Consulting authority and bibliographic files is much easier with the online file than it was with cards, and we find that people are more thorough than formerly.

8. All terminals in Catalog are used variously for cataloging, searching, maintenance, and word processing. We acquired terminals gradually over the years, and are still insatiable, but planning hardly came into it. We bought as many terminals each year as we could afford, weighing competing demands for terminals (pub servs, serials, acquis, cat, bindery, circ, public catalog, stacks, etc. against each other, and addressing the most crying needs first. Technical Services needs have always been fairly treated in this process.

II. Staffing

BEST COPY AVAILABLE

1. Technical Services was reorganized prior to automation (pre-order and pre-catalog searching were combined). Subsequent reorganization came about more because of personalities than automation. A Catalog Editor position was first officially created ca. 1973, but the functions had been performed before then. This evolved into Catalog Maintenance, and then Catalog Management, which includes an Authorities Unit. Generally, staff were not added, but positions were redescribed.

2. The question of labor and time savings is complicated. Acquisitions has reduced staff and increased efficiency. Catalog has added staff and functions, and after 15 years of automation is beginning to approach the productivity enjoyed prior to automation. We closed the author-title card catalog in Year One, and closed the Subject Catalog the next year. We had had been automated for more than a decade, and the online catalog had been available to the public for just under a year. Maintenance of the card catalog has gradually decreased. The card shelflist is maintained as part of the public catalog. We removed all NOTIS cards from the author title catalog last year, and will soon do the same with the subject catalog.

3. Training was performed in house by selected individuals. We have been automated so long that any difficulty in re-training has long since passed. We recall little trouble in that regard. Job content has generally been upgraded as have job classifications. We probably also get more from the same classifications than we did before. Catalogers know how to do catalog maintenance (except for global changes), but the usually request it from Catalog Maintenance.

4. We have had some inquiries about VDT hazards, and investigation of existing studies, but have had little pressure. Equipment is not ergonomically ideal. There are plans to replace existing workstations over the next three years.

I hope this package is what you needed. Feel free to call again if there is something unclear or unsaid.

Sincerely,



Janet Swan Hill
Head, Catalog Dept.

UNAVAILABLE COPY

AUTHORITY RECORDS--STANDARDS

Technical Services Decision
82-2 (JSH)
Mar. 24, 1982

Catalog Department Memorandum
82-1 (JSH)
Mar. 24, 1982 (r:3/15/83)

SUBJECT: Minimum Input Standards for NOTIS Authority Records

NOTE to Catalog Department Staff: The following standards are for NOTIS participants. Minimum standards for Catalog Department staff are more stringent.

Not all authority records created on NOTIS must be "full". Individual NOTIS participants may have different requirements for what information is necessary for their own use. Within an institution, certain types of records may be made more full than others. In order for the NOTIS system to manipulate the records, however, and so that the Catalog Department has information needed to use and/or manipulate such records, minimum input standards must be observed by all participants. The following are minimum requirements for NOTIS participants. Individual participants may decide that some or all of their authority records should have more information than indicated, but they may not input less.*

1. Any field included on an authority record is fully content designated.
2. The application of codes and fields is as interpreted by the Catalog Department.
3. The \$w subfield is supplied and coded as appropriate in any 4XX or 5XX field included in the record.
4. Information included in note fields is in general conformity with with the pattern (if any) set up by the Catalog Department.
5. The following fixed fields must be included and appropriately coded:
 - E/LEV
 - SRC
 - NUM
 - S/TYP
 - NAME, SUBJ, SER (coded with reference to the union file)
 - AUTH

*some early authority records, especially those retrospectively converted, may have less data than indicated. the practice has been discontinued, and should not be imitated.

April 1, 1983

- H/ESTAB
- T/EVAL
- IP
- RULES

6. The following variable fields must be included:

- 010 if available
- 040
- 1XX
- 4XX from a pre-AACR2 form (if any) used on NOTIS and/or in LC records; Any other appropriate see references.
- 5XX for earlier/later/related headings used on NOTIS by any participant; Any other appropriate see also references.
- 670 The source of the heading: If LC/AF (fiche or online), include record number. If LC/MARC bibliographic record, give NOTIS record number. If work cat, give NOTIS record number. If LC resource file in RLIN, give LCR and 010.
- 675 Record LC authority sources (LC/AF, LC/AF fiche, LCNH, or LCR) searched unsuccessfully.

7. If heading is a series, the following note fields must be included:

- 641, if appropriate
- 642, if series is numbered, etc.
- 643
- 644 for class together series. Not used for class seps.
- 645
- 646

RELATED MEMOS: CDM82-18, Creation and Validation of Authority and Cross Reference Information on NOTIS

ADDITIONAL FILING TERMS: Standards for Authority Records; Minimum Standards for Authority Records

CORRECTIONS

Catalog Department Memorandum
80-6 (JSH)
December 31, 1980

SUBJECT: Corrections to existing cataloging: Major vs. Minor errors

It is the goal of the Catalog Department to produce and maintain the most accurate and error-free catalog which the restraints of time and staff will permit. Any error in the card catalog or the machine database is therefore regrettable, but there is insufficient staff to correct them all and some errors are so insignificant that their correction does not justify the expense involved. A Library POLICY on this subject (PPM 573d,e,f) instructs non-Catalog Department personnel in what sorts of errors will be corrected, and how they should be reported. The purpose of this memorandum is to instruct Catalog Department staff in distinguishing between those errors which must be corrected, and those which can be "tolerated."

1. Major Errors (do submit for correction)
 - Errors, typographical or otherwise which occur in any entry field (main or added entries, subject tracings, the title proper, title tracings, series statements, or series tracings)
 - Errors in the call number
 - Errors in the date of publication
 - Errors in the transcription of a name in the body or notes which results in an added entry
 - Errors in edition numbering
2. Minor Errors (do not submit for correction)
 - Typographical or other errors in non-entry fields including the body of the entry (except in the transcription of names which are given as an added entry)
 - Typographical or other errors in the publisher or place of publication
 - Typographical or other errors in notes
3. Exceptions
 - Egregious errors in non-entry elements may be corrected if the cataloger judges that the patron would be misled by the existing information
 - Errors in non-entry fields may be corrected if a record is being revised or corrected for a major error or for any other reason.

BEST COPY AVAILABLE

BEST COPY AVAILABLE

4. Correcting Provisional Records

-- Corrections are not generally made to provisional cataloging data, but exceptions are made if an error is such that the existing data might hinder the acquisition of copy, or an index entry is being worked with in connection cataloging or authority work in progress. In such cases, Catalog Department personnel may alter "in-process" records, but requests for alterations to "on-order" records are forwarded to Acquisitions, Search Section. (See CDP External Concerns, no. 2, Item 4)

5. Reminders

-- Although a cataloger submitting a major error for correction may scan the remainder of the record for other possible corrections, the cataloger should generally resist the temptation to recatalog the item under scrutiny, or to update old cataloging to reflect more current rules.
-- From Jan. 1, 1981, a correction to a manual catalog record will require that the record be converted to the database. For this reason, when dealing with manual cataloging copy, catalogers should be reluctant to make exceptions to the rules against making minor corrections.

RELATED MEMOS:

PPM 573B.1-2 (Implementation of AACR 2)

PPM 573B.3-4 (Closing the Pre-AACR 2 Card Catalog)

Catalog Department Procedures, EXTERNAL CONCERNS, no. 2, Item 4; no. 3, Items 2,3; no. 4, Items 1,2; no. 6, Item 2.

SUPERSEDES: CDM 77-3

Additional filing terms: Revision of existing cataloging; Maintenance of catalog records; Manual cataloging--Corrections

[cdm0-6]

BEST COPY AVAILABLE

BEST COPY AVAILABLE

76



NORTHWESTERN UNIVERSITY

Inter-Office Correspondence

DATE January 17, 1984

TO Administrative Committee (McGowan, Bennett,
Combs, Horny, Jacobson, Query, Spalding)

DEPARTMENT various

FROM Janet Swan Hill

DEPARTMENT Catalog

SUBJECT: A PROPOSAL TO WEED THE MAIN AUTHOR-TITLE CARD CATALOG
OF COMPUTER-PRODUCED AND NON-NUL CARDS

The Catalog Department, and the Catalog Department as proxy for library users is faced with a number of problems which share a common answer. Since implementation of the answer would affect all segments of the library, explication of the problems and the proposed solution is provided below.

I. CURRENT PROBLEMS

A. Confusion of content of the card catalog vs content of the online file:

The break between the card catalog and the online file is not tidy, and can never be precise since older titles are continually converted to NOTIS when cataloging is handled: Noting short of conversion of all manual cataloging would resolve this confusion. Some confusion, however, exists not because of the "fuzzy" cutoff date, but because of imperfect redundancy between LUIS and the card catalogs. Although it will soon be three years since filing in the main Author-Title catalog ceased, many users believe that everything in LUIS is also in the card catalog. Despite the fact that nearly as many titles appear online as are represented only manually, and the fact that all the more recent titles are on the database, many staff and users still think of the card catalog as primary, and LUIS as a supplement. Continuation of these beliefs does not serve users well, and engenders mistaken searching techniques and expectations, but is encouraged by the substantial amount of machine-readable cataloging found in the card catalog.

B. Redundancy of LUIS and the card catalog:

The question of whether users would be confused by redundancy of information between the card catalog and LUIS was raised prior to the closing of the catalogs. The conclusion that it would not confuse them much assumed that cataloging

information appearing in both catalogs would be the same. This assumption is no longer valid. We must now wonder how confused users are by information that differs from catalog to catalog, while describing the same titles. (see below for conditions under which information may differ from catalog to catalog).

C. Inconsistent accuracy of data in the card catalog:

1. Cards from other libraries: NUL has in the past filed main entry cards from Garrett, NU Law, Medical, and Dental Libraries, from the NU Transportation Library, from the Midwest Inter-Library Center, and even from Evanston Public Library, but because we have not been notified when titles were withdrawn, reclassified, or recataloged, the reliability of the information is subject to question. In the aftermath of AACR2, cards from other libraries frequently pose problems in heading formulation and file conversion. Many have had to be pulled, and will not be replaced. The value of retaining incomplete and inaccurate information about titles not even in our collections, especially when retention contributes to processing inefficiencies and user misdirection is a topic for legitimate concern.

2. Catalog maintenance short cuts: In anticipation of AACR2 implementation, and because we were not yet mentally divorced from the concept of the card catalog as an almost sacred icon, elaborate plans were made for the "perfect" upkeep of the closed catalog. In order that all data remaining in the card catalog be accurate, any change in a machine-readable record with cards in the catalog was to result in removal of the complete card set from the catalog. It has been well documented that this level of upkeep could not be borne. Many categories of corrections were gradually excepted, and today only those changes that would hinder actual physical location of a piece reliably result in card removal. This non-conformance between the card catalog and LUIS is confusing to catalog users who may think the cards and the machine record represent different entities.

3. Batch corrections: Many major changes to headings in bibliographic records are made through batch corrections, where a single procedure can alter hundreds or even thousands of records, rendering perhaps five times as many cards inaccurate. More than 78,000 corrections have been made through batch programs in the past 3 years, representing perhaps 400,000 cards. Most affected cards remain in the catalog, as the "de-filing" load is too great for available hourly staff.

4. Temp slips: Items acquired but not cataloged prior to the availability of LJIS were represented in the card catalog by temporary catalog slips. Although cataloging procedures still call for removal of old temp slips when titles are cataloged, it is an easy step to overlook, and many slips remain in the catalog even after titles have been fully cataloged on NOTIS. Many manual temp slips remain in the card catalog even though the in-process record has been converted to NOTIS. Because temporary cataloging data often differs from final data, and because even temporary data may have been altered by a batch correction procedure, users frequently cannot identify temp slips with fully cataloged titles. RUBs are submitted, wasting time for users, Circulation, and Catalog Department staff.

D. Inconsistency of coverage of data in the card catalog:

While many recent catalog cards, whether correct or outdated remain in the card catalogs, many cards for older titles are absent, since manual card sets are pulled when retrospective conversion is performed. Users may not be confused by the inconsistency of coverage because it is generally invisible to them, but they are misled when certain types of data are present, and they mistakenly assume that it is all there.

E. Expense of pulling cards according to current guidelines

Although card pulling requires little training, it is not entirely expenseless, especially since the Department has tried to maintain a commitment to pulling full sets for cards that are removed. The equivalent of three student assistants working a 12-15 hour-per-week schedule was spent last year in card pulling alone. While much pulling centered around bibliographic conversions, some was corrections-derived. All pulling is made more time-consuming by the presence of more than a million redundant or unnecessary cards. The task itself is so distasteful that student assistants often choose to "clock out" and earn no money rather than to pull cards.

F. Expense to catalogers of the current catalog maintenance guidelines

Current catalog maintenance guidelines are inextricably wound up in catalogers' routines. Each time a heading is altered the card catalog must be checked, and the size of the file determined. Depending on the size and type of the file, correction or conversion requests must be submitted. Work done by catalogers is followed by work in Catalog Management. Since tasks are not separable from other routines, it is difficult to know precisely how much time is spent by catalogers and Catalog Management in dealing with the manual catalog (excluding the

actual pulling of cards), and since catalog checking would continue to be a part of cataloging routines until a local TOSCA were implemented (see below), it is difficult to estimate how much time would be saved by not having the cards to contend with.

G. Expense of redundant and/or inaccurate information on processing routines.

In addition to the difficulties inherent in simply dealing with more cards than necessary, heading and copy searching throughout Technical Services is hampered and made more confusing by the presence of outdated information. Unnecessary correction requests are often received for headings that have already been dealt with, and copy is sometimes thought to be variant when it is precise.

H. Difficulty of implementing TOSCA at the local level

The Library of Congress devised the set of routines called TOSCA (Total Online Searching for Cataloging Activities) as a means of increasing their cataloging productivity. Under TOSCA, LC catalogers establish headings with reference to the online file and without regard to what may be in the manual files. NUL original catalogers must take LC's TOSCA guidelines into account in connection with NACO cooperation, but so far implementation of a TOSCA of our own has been hindered by our continued allegiance to the card catalog. The need to understand and follow two basically incompatible philosophies and sets of routines for heading formulation does not enhance catalogers' productivity.

I. Retrospective conversion

As patron use of the card catalog continues to diminish in favor of LUIS, the need for more rapid retrospective conversion of our manual files becomes more clear. It is unlikely that any Library department will donate staff to us for retrospective conversion, or that funds for conversion will magically become plentiful through other means. Within the Catalog Department, the only way that recon can be increased is through elimination or reduction of other work currently performed. Given the improvements in cataloging routines of the past few years, and the elimination or simplification of many procedures previously performed, few activities remain to be cut. Card catalog involvement is the largest of those few.

J. Space

Demands for space within the building are increasing, not only for office and work space, but also for public use. Additional terminals in the main catalog area, space for a bibliographic instruction center, readers for the National Union

Catalog on microfiche, increased exhibit space, have all recently been mentioned as placing demands on the central lobby area of Level 1. Since building onto the lobby is impossible, means for making better use of the space we have must be explored. The single greatest occupant of that space is the card catalog. With the decrease in card catalog use which followed the introduction of LUIS, the space is increasingly "dead".

II. SOME ARGUMENTS FOR AND AGAINST WEEDING

Some of the problems listed above, specifically those relating to the Catalog Department budget and to cataloging productivity, would be eased by merely freezing the catalog as is, or to a lesser extent by ceasing to pull full card sets. The result of such half-measures, however, would be a catalog that was permanently confused, confusing, and unreliable. Alleviating the problems of inconsistency, inaccuracy, and unpredictable redundancy would require a more far-reaching plan, encompassing removal of computer-generated cards, temporary cataloging slips, and some categories of non-NUL cards.

** In addition to removing inaccurate information and eliminating confusion about differing information for the same titles in the two catalogs, etc., another benefit of weeding would be that all cards in the catalog would clearly be for older materials, making it obvious that LUIS is the place to go for current information.

** Hourly money would be freed in the Catalog Department, and could be redirected to retrospective conversion. The amount of ReCon that could be performed would depend on how fully TOSCA were implemented, on decisions regarding disposition of formerly manual card sets, on the degree to which general card-pulling were approved, on the staff performing recon, etc. It would likely not reach twice the current level, but might eventually be 150% of the current level.

** Removal of computer cards from the Author-Title catalog (and eventually from the Subject catalog), combined with compaction, could initially free at least two rows of card catalog cabinets (currently occupying ca. 1100 square feet), thus making prime space available for other uses. Continued reduction of the catalog through conversion would eventually free even more space, and some of this future shrinkage could be taken into account in the initial compaction.

The possibility of removing computer cards from the catalogs has been raised before, but was never seriously pursued. One reason was that many of the problems enumerated above, especially those related to inconsistency, inaccuracy, or incompleteness of coverage, were not completely anticipated, or were not yet significant. Some other reasons for inaction are discussed below.

A. Losing information:

It has been argued that information in the Catalog is at least available to users, and even though it may not be current, it should be retained. It has been seen, however, that much of the information is incorrect (although admittedly often in a minor way), and in addition, whether correct, incorrect, or nearly correct, the mere presence of information that to some extent duplicates data on LUIS can be confusing and misleading to users. We have all seen that users who find any information are apt to assume that they have found it all. When the file they are consulting is partly manual and partly duplicate to LUIS, such a conclusion must seem all the more reasonable. It is unfortunately wrong. In addition to the confusion it brings to users, extraneous and redundant information in our card catalogs enforces certain inefficiencies in Catalog Department and other Technical Services operations.

B. Backup for the online file:

When LUIS was first introduced, and its reception was uncertain, we were wont to say that the card catalog would provide an initial backup to the online system. It has now been three years since any new cards were filed into the catalog, and the adequacy of the cards as a backup to LUIS is increasingly questionable. Even if it were completely up to date, we have seen that users of the online catalog do not go to the card catalog even when the system is down, or when they must wait for a terminal. They wait for LUIS. The argument for the catalog as backup is also very thin when system reliability exceeds 99%.

C. Expense:

Another argument that has been used against catalog weeding is its expense. A preliminary test was performed in 1982, and tended to bear out speculations that the cost of weeding was not insignificant. A recent repeat of the test, however, has called the previous experiment into question, and suggests that the time involved may be less than half that originally projected.

The Catalog Department budget could not support hiring students specifically for catalog weeding, but the Department has a history of using permanent staff in catalog maintenance

operations. Until Day One, all catalogers performed filing or filing revision as a part of normal routines, and it was not in the least uncommon for all department staff to be called upon to perform some special catalog project. Divided among existing staff as "the last great card catalog project", weeding could be done without spending any extra hard money, and if properly paced, would bring minimal disruption in production. There is no doubt that all department staff who must deal with the card catalog in its present state would eagerly accept a weeding assignment. There would be few activities we could embark on that would do so much for Department morale at so little cost.

III. THE PROPOSED PROJECT

The main Author-Title card catalog would be purged of

- ** NOTIS computer-generated catalog cards.
- ** Law Library cards. Because of Law's recataloging and conversion project, all Law cards will be obsolete and duplicate to NOTIS within the next year.
- ** Evanston Public Library Cards. These cards do not enhance our catalog coverage. There are very few of them, and for the most part they either duplicate titles held in NUL, or are for items too general for a research Library.
- ** All temporary catalog slips. The backlog is now totally represented in LUIS.

Many categories of non-NUL cards will remain in the catalog. Although the information contained on NU Medical, Dental, Transportation, and Schaffner unclassified cards, and on Garrett or Midwest Inter-Library Center cards cannot be relied upon, much of it still reflects current holdings, and it has been argued that the mere presence of a card from another research collection which the user may not have known about has a value of its own.

Work would be done by student assistants already assigned to card pulling routines, and by Catalog Department permanent staff making a single run through the catalog. Permanent staff would pull cards for about a half hour per day, or 2.5 hours per week. Depending on the amount of student hours devoted to the project, pulling could be complete in as little as 15 weeks, or could take as long as 26 weeks (6 months). Because of the pace and scope of the project, cards would be pulled one at a time, and not by sets.

After weeding, compaction of the catalog would take place, and drawers would be relabeled. Although weeding of the Subject Catalog would not take place until more satisfactory subject authority routines are in place, this file might also be compacted, since it is not growing. Routine maintenance card pulling from the Subject catalog would be halted when the Author-Title weeding project began.

IV. CONCLUSION

The card catalog as it currently exists is no longer a tool in which the Department or the Library can take pride. For certain internal functions, it is hardly a tool that can be used. Our intentions were laudable, but our money and time were limited, and the plans we made were unrealistic. No one knows as well as we just how unsatisfactory the catalog has become, and how much less satisfactory it is destined to become if current maintenance procedures must be continued. In the years preceding introduction of the online catalog it was impossible to envision how much LUIS would supplant the card catalog, and it was also impossible to determine the extent of maintenance activities that would be generated through local AACR2 implementation. In addition, Catalog and other staff had an emotional attachment to the catalog that has taken years to wear down.

By now the results of past decisions are clear, our distrust of the new catalog has been overcome, and our partial blindness to the problems of the old catalog has been healed. We have nothing to be ashamed of in our previous attempts at preserving "the old ways" through continued maintenance of the card catalog. We would have something to be ashamed of, however, if, having seen the problems that have arisen through current policies, we did nothing to point them out and correct them.

Should the project be approved, publicity would have to be considered, and it would need to be determined how best (or whether) to announce the project to staff (The Lantern's Core or a staff announcement), to regular library users, and to the University Library Committee. Informational handouts, orientation scripts, signs, LUIS screens, etc., would need to be examined to determine if alterations were necessary.

Attachment: Test results

cc: Furlong, Ashley, Andez,
Janekiw, Garrison

Card-pulling tests: comparison

	<u>VHG/JDG 3/82</u>	<u>JHL/MMC/JGM 11/83</u>
Project A: to purge A-T catalog of all computer cards		
Total time per drawer:	29 min.	12.5 min.
Average no. of cds pulied (per drawer)	195	230
Reduction in the size of the drawer (avg)	22%	21%
Size of sample	5 drawers (44" cds)	29 drawers (260.75" cds)
Time estimate to complete project	1686 hrs	720.2 hrs
Project B to purge A-T catalog of all computer cards, contributed cards, temp & in-process slips		
Total time per drawer:	40 min.	15.8 min.
Avg. no. of cds pulled (per drawer)	300	300
Reduction in the size of the drawer (avg)	34%	33%
Size of sample:	5 drawers (43.75" cds)	29 drawers (260.75" cds)
Time estimate to complete project	2325 hrs	910.3 hrs
NOTE: average drawer size in sample no. of drawers in catalog (on which time est. to complete is based)	8.75"	9"
	3487	3457

TOTAL cards pulled for test

no. of contributer cards

no. of NU, music, etc computer cards

85"
(9500 cds)

18 1/2"
(1250 cds)

60.5"
(6050 cds)

BEST COPY AVAILABLE

Card pulling test - Appendix: the K-slip report

Total number of k-slips, in-process slips, etc. pulled from catalog: 395

manual slips: 25

comp. slips: 370

1. Computer-generated slips (T's, K's)

NOTIS 1 (T-card): 8

NOTIS 2 (K-slip): 130

NOTIS 3 (K-slip): 232

sub- Total of the above which were found to have been cataloged: 49

NOTIS 1: 3

NOTIS 2: 16

NOTIS 3: 30

sub-total of the above which were found to have remained the same: 319

location analysis of 300:

	<u>NOTIS 1</u>	<u>NOTIS 2</u>	<u>NOTIS 3</u>	<u>total ea. loc.</u>
main	4	65	87	156
afri		29	90	119
spec		13	9	22
spec, pam		[9]	[8]	17
main, mi			2	2
curr		1		1

analysis of corrections made to 19:

	<u>NOTIS 2</u>	<u>NOTIS 3</u>
prov.m.e.error	3	6
DT/ladded or corr	2	5
PTI corr		1
hldg code corr		1

2. Manual on-order and in-process slips

Total: 25

also on NOTIS: 12

of these: 4 were cataloged

2 had a diff.m.e. than the slip

2 had a diff. location than on the slip

4 records required correction: "D" prefix added to order no. (2)
Bibl. corr. (2) [1 MPM, 1 TSU]

2 were exactly the same

2 required further research

the totally manual slips

by location: main:16 (2 'blue' no., 2 C-, 7 D-, 4 E-, 1 IP unknown ver.)

spec: 5 (1 'blue' no.)

[4 "uncat-ask in spec"]

BEST COPY AVAILABLE

core: 1

probable art ephemera: 3

K's not pulled from OAT for cataloged books

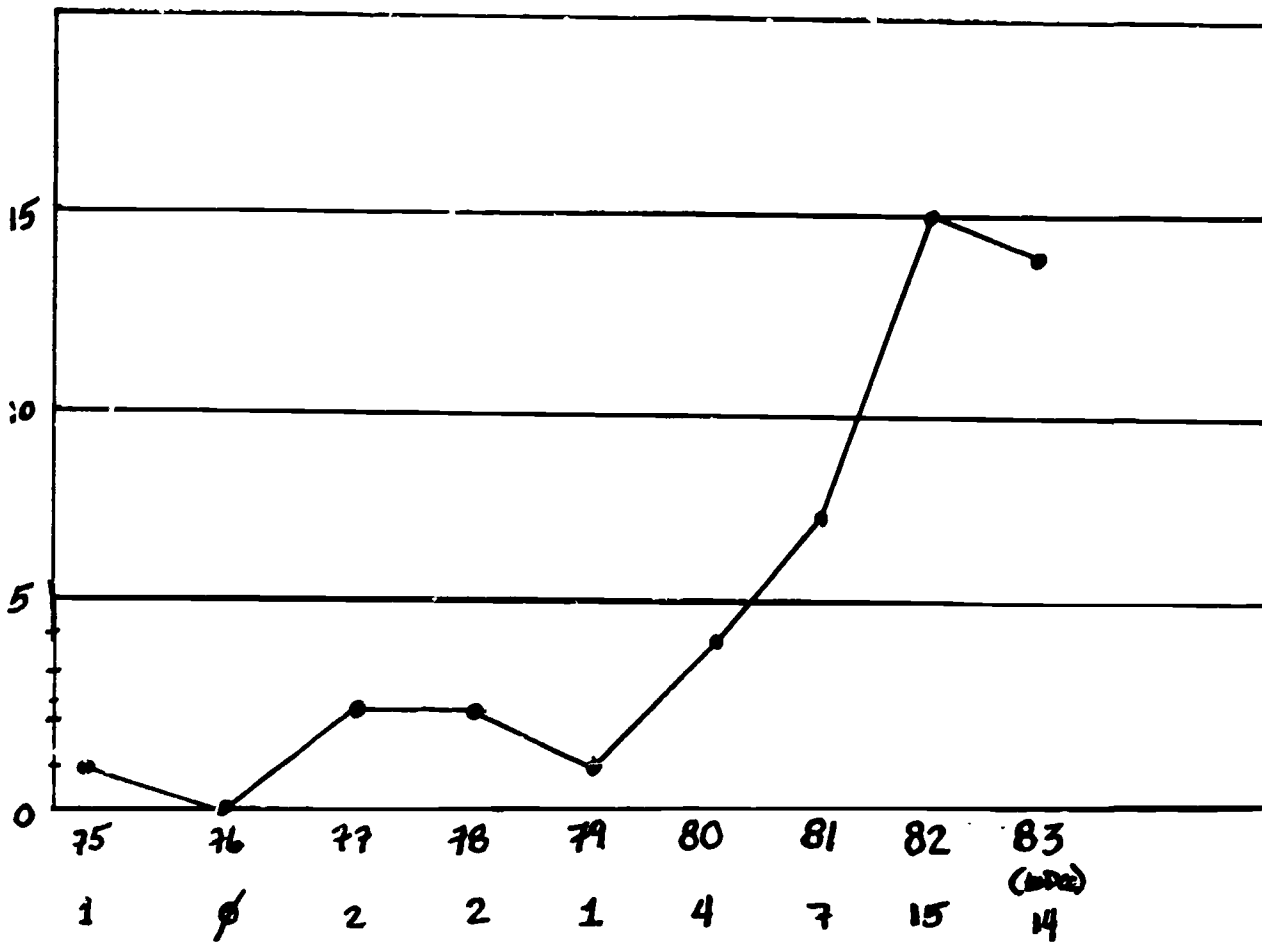

VTLS AUTHORITY CONTROL: GOALS AND OBJECTIVES

Authority control in a library catalog is based on two traditional principles:

- 1) There should be only one unique form of entry for each personal name, corporate body, subject tracing, series and uniform title.
- 2) The user should be directed to the works collected under each unique entry by cross references from variant forms and by linking entries from related headings.

The first principle has been adopted by our library so as to follow AACR2 and Library of Congress rule interpretations, as well as to fulfill our contractual obligations to OCLC. The second principle aids in the patron's access of our collection.

With the advent of online authority control on VTLS we can now add a third principle to the list:

- 3) Online authority records should prohibit the use of incorrect entries in an online data base.

Currently, this third principle is available on VTLS only for names and subjects. Authority control for series and uniform titles will be developed for future release.

Based on the above principles our goals and objectives for online authority control should be as follows:

- 1) Collate all individual tracings for personal and corporate names, subject tracings, and series under one unique form of entry for each heading.
- 2) Provide cross references from variant entries to correct form of entry and see also references between related headings.
- 3) Provide the necessary catalog maintenance resources for entering authority records and resolving the conflicts that arise.
- 4) Record authority decisions and justifications online.

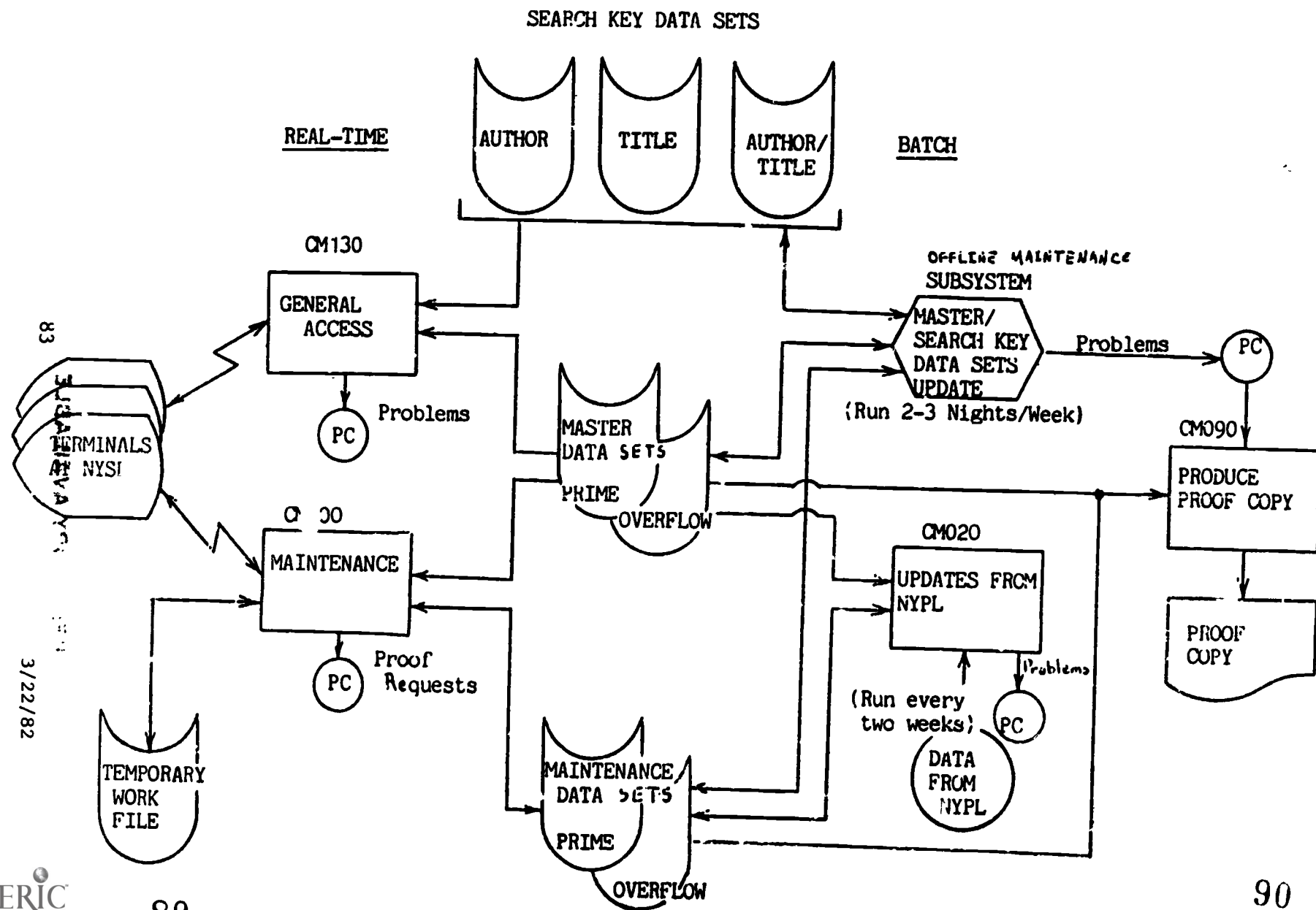

83
3/22/82



ORIGIN AND LOCATION OF BIBLIOGRAPHIC DATA
 AT
 THE NEW YORK STATE LIBRARY
 NOVEMBER 1981

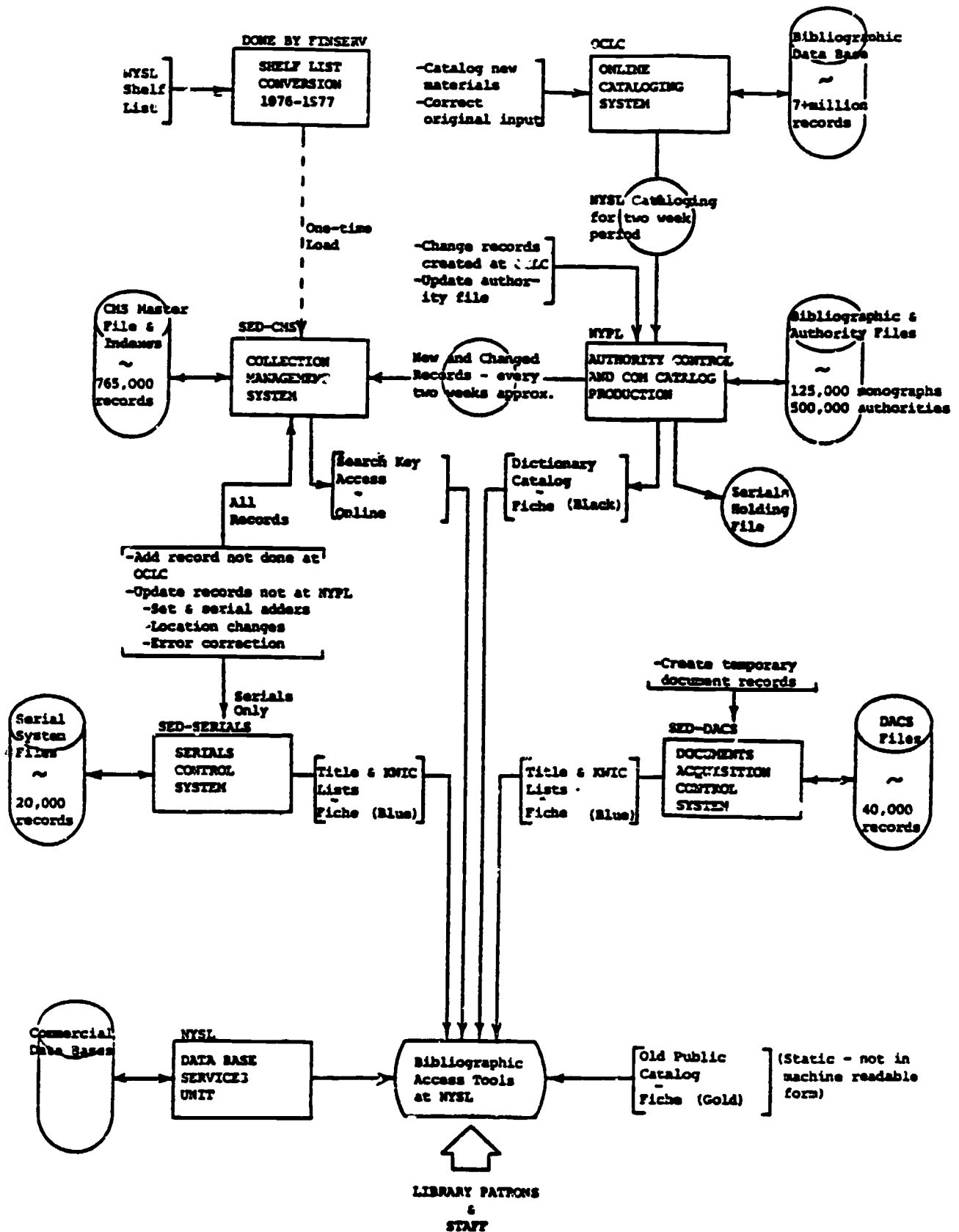

I. CMS OVERVIEW

(A) General

The Collection Management System (CMS) is a computerized system designed to improve speed and efficiency of library services. Phase I of CMS was implemented in April 1980. The focal point of this Phase is a 795,000 record masterfile representing the State Library's catalog. Components of the database are 655,000 converted Shelf List records, 124,000 catalog records created since December 1973 via the OCLC shared cataloging system, and approximately 6000 records created through CMS.

(B) Access Methods

There are two types of access to the CMS masterfile under Phase I: search keys and record ID. Search keys are derived from significant words in the author and title fields. For example, the book The Electronic Library by Roger W. Christian, can be accessed by any one of these keys:

Author Key	CHRI,ROG,w'
Title Key	ELE,LI,,
Author/Title Key	CHR' ELEC

Search keys are the main access point for general staff and patrons. Record ID is used primarily by catalog maintenance staff.

(C) Update Methods

- (1) An on-line maintenance module allows that library staff to change and delete records from the original Shelf List conversion. It also allows new records to be added to the masterfile.
- (2) Catalog records generated via OCLC are not added directly to CMS. A satellite master file is maintained on the Bibliographic-In-Process System (BIPS) at New York Public Library (NYPL) for these records. At NYPL, the bibliographic file is under automated authority control and is used to produce a dictionary catalog on microfiche for all cataloging since 1973. The 124,000 records on this file may not be updated via CMS. A special terminal is available for this purpose, one that accesses the satellite master file at NYPL. Periodically, the result of maintenance activity at NYPL are sent to Albany where they are integrated into CMS. In this way, the OCLC data in CMS is kept congruous with the subfile at NYPL.



THE UNIVERSITY OF NEW MEXICO □ ALBUQUERQUE, NEW MEXICO 87131
GENERAL LIBRARY □ TELEPHONE: 505:277-4241

July 31, 1965

Gillian M. McCombs
University Library
State University of New York
at Albany
1400 Washington Avenue
Albany, New York 12222

Dear Gillian,

As I promised, enclosed are job descriptions, organizational chart, and some DataPhase procedures.

We do not have bibliographic maintenance procedures, per se. The changes to bib records are made by OCLC Specialists and LTA Is who have US MARC tagging experience and OCLC inputting and editing experience. Change requests or copies of errors on catalog cards are sent to Automated Processing and/or Catalog Records for the operators to use to change the bibliographic record in the database. This has worked well, since both OCLC and DataPhase use the USMARC formats and transfer of training is relatively smooth.

Our department is in a transition phase. Although we designed the Automated Processing section to handle OCLC-LC cataloging and DataPhase database maintenance, we are overlapping more and more with other processing units as we evolve towards thinking in terms of the machine-readable record instead of the catalog card. We have not closed our public card catalog and we are not using DataPhase as a public access catalog. However, planning is underway for automating many functions in the library and the public access catalog is one.

Hope this information is of use to you. Thank you again for including University of New Mexico General Library in your survey.

Sincerely,

Janet Frederick
Automated Processing Librarian
Acting Head - Processing Units of Bibliographic Control

P.S. Kristi Tornquist
University of Wisconsin, Stout, is the person to contact re utilizing DataPhase as a public access catalog.

LINKING ITEM RECORDS FOR TITLES BOUND TOGETHER

Examples of titles that require item records to be linked are classed together, analyzed, titles bound in one volume, or several titles filmed together on one microfilm reel.

The following procedure is designed to link several item records to one main item record so that staff or patrons can determine whether a title is available even though it is bound with other titles.

Only one OCR label is placed on the piece and that OCR number is used to create the item record for the first title in the piece.

STEP ONE: Item Conversion of the first title.

A. Go into the Item Conversion (CON) function. Retrieve the bibliographic record for the first title in the piece by searching by vendor (OCLC) number, LCCN, etc.

B. Once an exact match is made, write down the Bibliographic Record Number on a sheet of paper. This number will be used as part of the call number for all subsequent titles bound or filmed together in the piece with which you are working.

CONVERSION	BIBLIOGRAPHIC RECORD NUMBER 187116
LDR 00708nam 22001811i 450	
001 †ocn02569257 810720	
008 †761119s1959 utus	00010 eng d
040 †aTFW†cTFW†dIQU	
049 †sIQUU	
099 †aE†s51†sU8†ano. 36	
100 10†sHoodbury, Anus Munn,†d1886-	
245 10†sSurvey of vegetation in the Glen Canyon Reservoir Basin	
/†cbv Anus M. Hoodbury, Stephen D. Durrant, Seville	
Flowers.	
260 0 †aSalt Lake City †bUniversity of Utah Press,†c1959.	
300 †avi, 56 p. †bill. †c28 cm.	
440 0†aAnthropological papers (University of Utah) †vno. 36	
440 0†sGlen Canyon series †vno. 5	
450 0†sBotany†zGlen Canyon Region.	

SUNAJIAYA (500) 1000

C. Accept the bibliographic record and proceed with the steps towards item conversion, with the following two exceptions:

1. Field 6: Call #: Type in the call number as it appears on the piece; i.e., so that it reflects all the numbers of the titles in the piece. See Example 1.

2. Field 11: Item Note: Type in a bound with statement as shown in Example 1, to indicate the number of the first title and to explain that it is bound with others.

D. File the item record by typing in the OCR number that is on the piece.

EXAMPLE 1

```
LCCN:                ISN:
AUTHOR:Woodbury, Angus Munn,1886-
TITLE:Survey of vegetation in the Glen Canyon Reservoir Basin /by Angus M. Wood
ED:                PUB:Salt Lake City :University of Utah Press,195
LAST PROCESSING: 2/24/84  LAST CIRC:                CIRCULATIONS:
ORIGINAL BRANCH:                ORIGINAL LOCATION:
CIRCULATION STATUS: SH                HOLD STATUS:
                                     .
1.MEDIA: BOOK                2.BRANCH: ZIM                3.LOCATION: GC
4.PRICE: 22.55                5.PREFIX:
6.CALL #: E51 U8 no.36-38
7.VOL:
8.ITEM LOAN PER:                9.PROCESSING STATUS:
10.DISCHARGE NOTE:
11.ITEM NOTE: No. 36, bound with nos. 36-38

OCR # 2528138
ENTER: FIELD NUMBER(S): EDIT FIELD(S) (E.G. 4 OR 5-7)
      D: DELETE, R:REFRESH SCREEN, Q: QUIT, H: HALT
      S: STORE
      :
```

BEST COPY AVAILABLE

88 3JBAJAVAVO 198

95

UNIVERSITY OF NEW MEXICO

CALL NUMBER FORMATTING FOR ITEM RECORD IN DATAPHASE

No spaces between classification letters and numbers:

PS3560

One space before each cutter: and - NO DECIMAL BEFORE CUTTER

PS3560 L42 M5

One space before date, year, no., vol., etc. if it exists as part of call number: (use lower case letters)

PS3560 L42 M5 1978

or: PS3560 L42 M5 vol. 2

One spaces within number or volume designation:

PS3560 L42 M5 no.5

For "unusual" call numbers, format as you would in an 099 field (i.e., as it would appear on catalog card, a space before each new line) except for the class part of the number:

GV201 07 U0-75 279-80

SU DOCS NUMBERS:

These should be input as they would in the 086 field on OCLC (in Books Format, p. 0:69) except that we put a # (number sign, shift 3) in front of the number.

Essentially the directions say "supply a space between any letter or number not separated by punctuation, and in front of parenthetical info."

Example: #C 46.8:L 78/970

#Y 4.P 96/10:N 81 d

TAKE OFF SHIFT (ALPHA LOCK) WHEN TYPING NO. OR VOL. OR LOWER CASE LETTERS AT END OF CALL #.

QUALITY CONTROL POLICY
FOR DATAPHASE DATABASE

The DataPhase circulation system is a multi-library database consisting of bibliographic, item and patron records of the University of New Mexico General and Law libraries. A multi-library database is defined as one in which libraries can share bibliographic records but maintain separate item (copy, vol., etc.) and patron records. Additionally, system parameters such as loan periods and media types are unique for each library in the system according to a pre-established profile.

Because libraries can share bibliographic (title) records, the following policy for defining, reporting and correcting errors in the database, as well as limiting duplication of title records, is hereby established.

Duplicate Bibliographic Records

Attempts will be made at all times not to add duplicate bibliographic records to the data base. If a duplicate occurs for the same library, the incoming record will replace the record in the DataPhase database by a manual replacement operation.

The workflow of technical processing of newly acquired items will incorporate a search of OCLC for duplicate holdings (IQU or NML) and/or a search in the DataPhase database for a bibliographic record to which an item record can be attached, before cataloging is done. However, if an existing bibliographic record input by one library is

deemed less than adequate for use by the second library, the second library may add its own OCLC or original record to the database.

If a library finds a title in the DataPhase database for which a copy has been newly acquired, a unique item record for that copy should be added to the existing bibliographic record. If the library wishes to change any data in the existing bibliographic record, and the title was cataloged by another library sharing the system, the library wishing the change should fill out a request to change specific fields in the existing record. If the library using the other library's bib record wishes to add any data to the bib record, a request will not be necessary.

In no case will a library delete fields from a bibliographic record unless it was the library responsible for inputting the record into the database and there are no item records from the other library attached to the bib record.

Error Reporting

There are three types of records where errors can occur in the DataPhase database:

Patron Record

Bibliographic Record

Item Record

Patron Record: The patron record input and maintenance will be handled solely by the circulation department of each library, and for the most part, will not be accessible except by specified personnel in

each library.

Bibliographic Record: The bibliographic record can be shared by libraries connected to the system. That is, a title held in common by the General Library and the Law Library might have only one bibliographic record although each library will enter and maintain its own item records.

The bibliographic record is created through (1) tape input of OCLC cataloged records, (2) original input through the cataloging mode of DataPhase, (3) tape input of records from vendors other than OCLC (e.g., Serial records from computing center), and (4) a direct link from OCLC to DataPhase.

When an error is noted or a change requested in a bibliographic record, a change or correction request similar to the form on page 5 will be submitted to the DataPhase maintenance staff of the appropriate library. Changes or errors reported should be limited, for the most part, to indexed fields. Changes should not be requested for those variances that are due to cataloging decisions. Changes will be made to headings to conform with the specific library's authority records. The form will be forwarded to the inputting library as indicated by the data in the 049 field.

Following are the kinds of errors that OCLC specifies as legitimate to report. These should be applicable to our situation:

I. Errors that affect retrieval.

- A) Errors in transcription of bibliographic data, such as missing or transposed letters, numbers, words, or punctuation.
- B) Incorrect assignment of a tag. Do not report variations in a series tag for another library.
- C) Incorrect or missing subfield codes.
- D) Incorrect or missing non-filing indicator codes.
- E) Incorrect form of name (1xx, 4xx, 6xx, 7xx, 8xx) if the form of name in the record does not match the authority record. Report only discrepancies for your own library.

II. Other

- A) Incorrect assignment or omission of fixed field values.
- B) Incorrect or missing punctuation or spacing prescribed by ISBD.

The following are indicative of additions that could be requested or added if known:

- A) Additional access points to enhance retrieval of online record, such as LCCN, ISBN, ISSN, subject headings and added entries.
- B) Additional linking entries for serials.

The following are examples of the types of "errors" that should not be reported:

- A) Spacing in the 300 field (collation).
- B) Final punctuation in subject headings.

- C) Delimiting subtitle from title.
- D) Changes in series tags or transcription of a series on a record of another library. However, you can report errors on series tags or transcriptions of series that do not conform to the authority record for your own library.
- E) Any minor variations in punctuation, capitalization, and abbreviations.

BIB RECORD MULTI-LIBRARY FORM

_____ CHANGE REQUEST (add or delete data)

_____ CORRECTION REQUEST (error in data)

049 field data _____

Bib record no. _____ Vendor (OCLC) no. _____

CHANGE FROM:

Line no. _____ Tag no. _____ Indicators _____

Field content _____

CHANGE TO:

Line no. _____ Tag no. _____ Indicators _____

Field content _____

COMMENTS OR AUTHORITY _____

NAME _____ DEPT./LIBRARY _____

DATE _____

Item Records:

The item record is a record of an individual copy, volume or number of a title. The item record carries the data necessary for circulation and inventory control of a specific piece.

The updates to an item record

will include such changes as transfer of an item from one location or branch to another, adding a copy (new item record), change in media type--a.g., from "BOOK" to "NOCIRC" or vice versa-- and the addition of a processing status such as "Bindery" or "Missing."

Such changes to an item record as loan period and discharge notes will be entered by the circulation department staff at the individual libraries. Also, Temporary (on-the-fly) item records will be created by the circulation department. Copies of these temporary records will be forwarded to the item maintenance (or retrocon) staff for completion.

The following is a draft form which might be used by departments in the libraries to request changes in an item record:

Item Record -- Change Request

*Item no. (OCR number) _____
Field no. _____ Field name _____
Call number of item _____

CHANGE REQUESTED:

Name _____ Date _____
Dept. _____

*Must have this information to ensure that change is made to the correct item.

**Bibliographic Resources and
Services Division
Organization Chart**

PENNSYLVANIA STATE UNIVERSITY

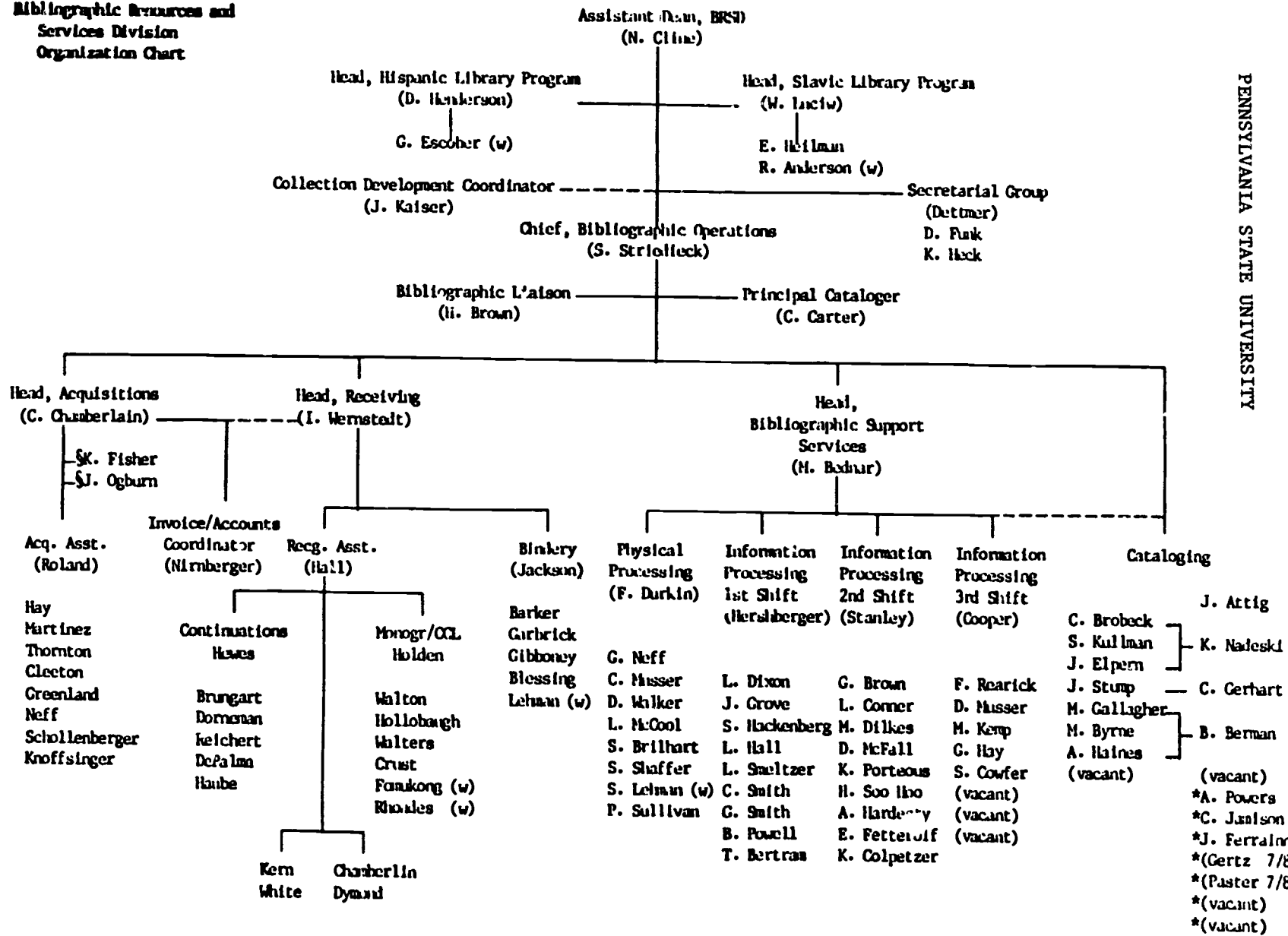

98

105

106

BEST COPY AVAILABLE.

* RISD split assignments
§ BRSD split assignments



NORTHWESTERN UNIVERSITY LIBRARY
Technical Services Division
Organizational Chart

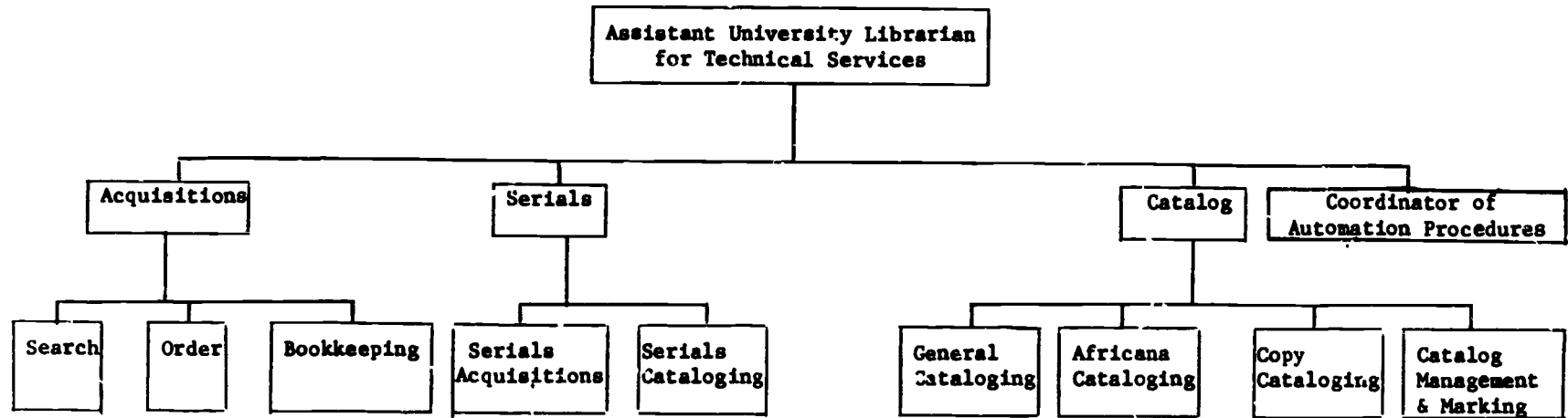

66

107

1982
108

APPENDIX VII: ORGANIZATION CHART

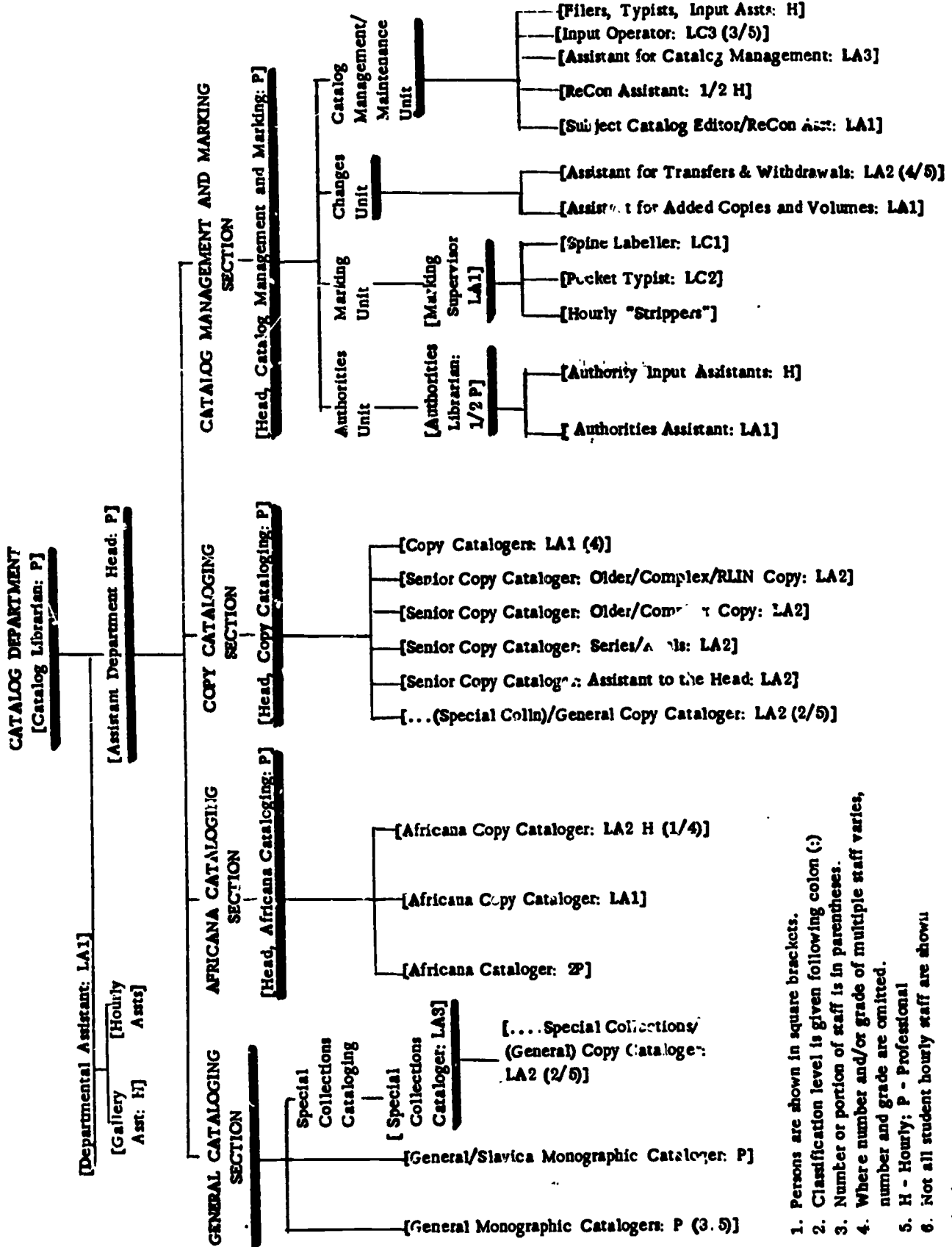

1. Persons are shown in square brackets.
2. Classification level is given following colon (:)
3. Number or portion of staff is in parentheses.
4. Where number and/or grade of multiple staff varies, number and grade are omitted.
5. H - Hourly; P - Professional
6. Not all student hourly staff are shown

9/27/84



NORTHWESTERN UNIVERSITY LIBRARY

March 1985

Acquisitions Department -- Organization Chart

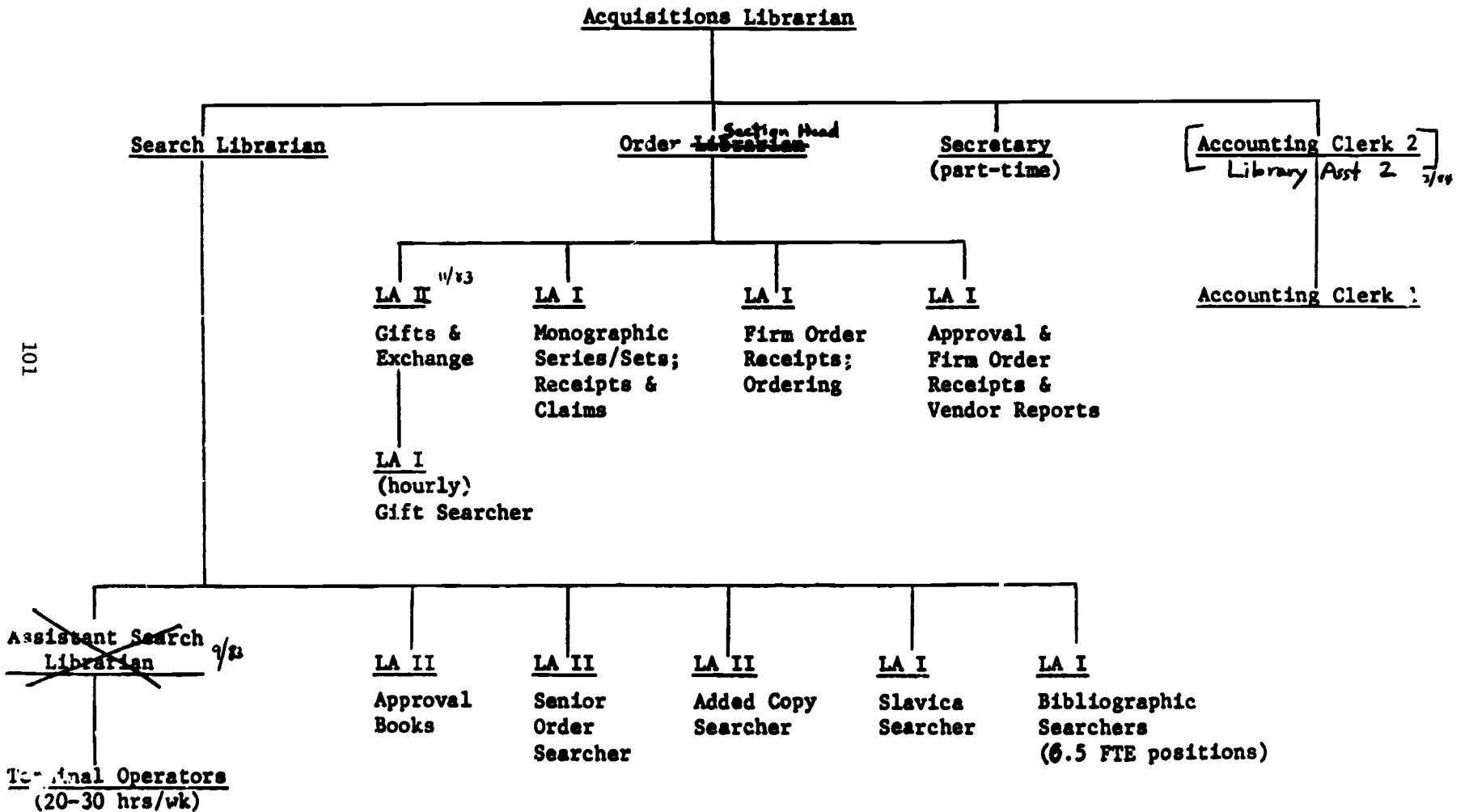

101



12/05/83

NORTHWESTERN UNIVERSITY LIBRARY. TECHNICAL SERVICES DIVISION. SERIALS DEPARTMENT. ORGANIZATION CHART

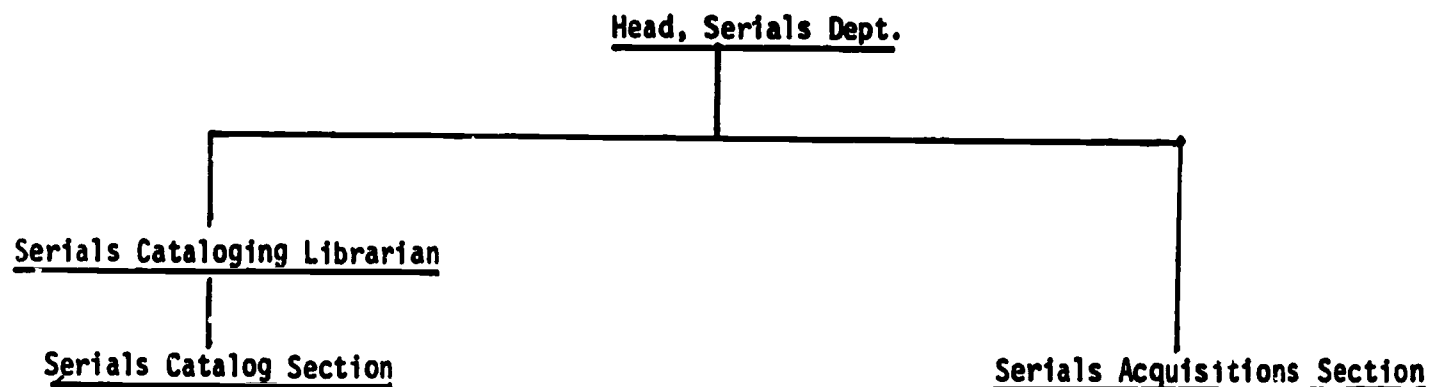

102

Serials Cataloger

Serials Cataloging Assistant (LA2)
Serials Cataloging Assistant (LA2)
Volume Holdings Assistant (LA1)

Terminals: 2

Laser Scanners: 1

Approx. 13,000 active serial records
Approx. 56,000 total serial records

Order Supervisor (LA2)
Invoice Assistant (LA1)
Claims Assistant (LA1)
Check-in Assistant (LA1)

Student Assistant (AL4)
Student Assistant (AL4)
Student Assistant (AL4)

Terminals: 5

Laser Scanners: 1

112

113

UNIVERSITY OF MARYLAND LIBRARIES - COLLEGE PARK CAMPUS
POSITION DESCRIPTION FORM
ASSOCIATE STAFF

Date Prepared: 11/85 Division: Technical Services
 Prepared by: [REDACTED] Department: Catalog Maintenance/Post Cataloging
Book Control
 Position Rank: AL I Unit: _____
 Specific Position Title: Catalog Management Assistant Librarian
 Reports to: [REDACTED], Head, Catalog Maintenance Dept.

NATURE OF WORK:

Provides professional support for research dealing with the integrated automated library database and its impact on catalog function and structure. Database is shared by several campuses.

Position Requirements:

Education: MLA from an ALA accredited graduate institution.

Experience: Requires completion of basic coursework in automated data processing and systems analysis; familiarity with the MARC format; strong oral and written communication skills; and familiarity with AACR II.

Familiarity with integrated bibliographic databases and OCLC (or another bibliographic utility) desirable.

DESCRIPTION OF DUTIES AND RESPONSIBILITIES:

1. Maintains a list of standards required of the on-line databases by the department. Assists in developing the list.
2. Researches and reports on the ability of the on-line system to meet the above standards.
3. Researches, reports and follows up on strengths and weaknesses of the on-line system in general and individual records in particular.
4. Tests enhancements to the on-line system and prepares or edits training manuals to reflect current system capabilities.
5. Maintains proficiency in use of databases by correcting bibliographic and holdings data assigned by supervisor.
6. Analyses statistics and reports as requested
7. Receives all department reports of terminals and printers needing repair. Reports problem to LIMS and supervisor. Ensures that repairs are made.
8. Files in Union Catalog according to ALA rules.

POSITION DESCRIPTION FORM

Academic
(College/School/Division)

Library
(Department)

Technical Services/
Catalog Maintenance Dept.
(Department Sub-Division)

LTA III

STUDY NUMBER AND PRESENT CLASSIFICATION (If None, Leave Blank)

A. PURPOSE OF POSITION

To add monographs to the library system when automated bibliographic records exist; to maintain the accuracy of the monographic Union Shelf List; to identify, research and correct problems with call numbers, bibliographic content of records (continued...)

B. DUTIES AND RESPONSIBILITIES (List major duties in descending order of importance, indicating the approximate hours per week or percentage of time spent in performing each duty)

1. Prepares for processing monographs going to locations with prior holdings:
 - a. Receives incoming monographs from the Acquisitions Department.
 - b. Trains and revises student assistants' work including matching acquisition forms to item, pulling shelf lists; writing temporary shelf lists, problem spotting.
 - c. Decides whether the shelf list is a true match or a new bibliographic record is needed according to UMCP and national cataloging standards; consults with supervisor as necessary.
 - d. Searches for a matching automated record on Geac, the university-wide on-line database by applying UMCP cataloging standards for a matching record; if a record is found material is forwarded to other department staff for completion; if no record is found sends material to Bibliographic Support Dept. for creation of an automated record.
 - e. Resolves problems created by non-standard activity.
2. Identifies, researches and corrects problems with already processed monographs.
 - a. Receives reports of problems from all levels of staff and patrons throughout the library system; directly identifies problems in the course of routine work; problems may include: errors in bibliographic content, call numbers, location of material, holdings records, and duplication of card and/or automated bibliographic records.

(Continued ...)

C. FINANCIAL RESPONSIBILITY (Dollar value of budget, equipment, or property for which position is responsible. List equipment or property elements)

None

D. ADDITIONAL FACTORS

1. KNOWLEDGES REQUIRED FOR PERFORMANCE OF THE WORK

Sound knowledge of MARC format, bibliographic search procedures and clerical cataloging procedures; general knowledge of the cataloging requirements of all the libraries in the system; familiarity with Anglo-American Cataloging Rules; (Continued...)

2. SPECIFIC SKILLS REQUIRED FOR PERFORMANCE OF THE WORK

Ability to use several types of CRT terminals; ability to type; ability to organize work and work independently; strong ability to communicate with colleagues; strong demonstrated problem-solving skills; basic (Continued...)

3. SUPERVISORY RESPONSIBILITIES (Give title and study number of each position which reports directly to this position)

Acts as lead worker for 20-30 hours of student work a week.

A. PURPOSE OF POSITION (continued)

and holdings of already processed monographs and to provide clerical support at the advanced level for the department.

B. DUTIES AND RESPONSIBILITIES (continued)

- b. Analyzes problems and researches all aspects using information from OCLC printouts, Geac database records, local ACC bibliographic system, Union Shelf List, calls to libraries and any other resources as needed.
 - c. Initiates preliminary correction procedures according to detailed department guidelines; supervises and revises pulling of defective cards and books from McKeldin and Hornbake catalogs and stacks.
 - d. Follows department guidelines for sending problems to supervisor, dept. head or solving independently.
 - e. Corrects bibliographic errors in accordance with UMCP cataloging policy, AACR II, LC classification and LC subject practice; ensures that corrections are made to books and card, format bibliographic records; edits on-line bibliographic and holdings record on Geac using correct Marc tagging, Geac editing techniques and proper Geac format for holdings records; indicates need for and provides corrected information for recataloging.
 - f. Maintains consistency of data in Union Catalog, Hornbake Catalog and Geac database; assigns corrections work to students when appropriate and revises all work done by them.
3. Receives and processes daily production of catalog cards from OCLC:
- a. Matches Union Shelf list cards against proof sheets of OCLC screen provided by Bibliographic Support.
 - b. Verifies accuracy of call numbers, location and holdings data, requires ability to interpret 153 holding codes.
 - c. Ensures that branch libraries and Union Catalog have correct card sets.
 - d. Solves problems including cards for which no paper record exists and paper records for which no cards arrive.
4. Maintains accuracy of Union Shelf Lists, the library system's authoritative record of bibliographic records and holdings; Maintains accuracy of Hornbake Library Shelf list:
- a. Revises all filing into the Shelf list.
 - b. Resolves problems by processing non-standard activity using routines in point 2 a-f above.

SUPERVISION RECEIVED (Name and title of immediate supervisor of this position, and the nature of the supervisory controls)

[REDACTED] Clerical Supervisor for Monographs, LTA IV exercises direct supervision.

5. COMPLEXITY OF DUTIES (Describe the tasks involved in a way that would indicate the level of difficulty)
Tasks involved are intricate. Identification and resolution of problems both within the department and the division require considerable intellectual effort. This position and its three associated positions are responsible for correctly identifying and resolving all problems with all cards and physical pieces for the entire UMCP Libraries system. The integrity of the Shelflist and its information is directly dependent upon them. There is a high volume of activity to be verified. The position is required to have thorough recall of all the department procedures, many of which are very complex. (Continued..)
6. GUIDELINES (Describe the nature of guidelines and other controls and the judgment needed to apply them)
A wide variety of manuals and documentation are provided; considerable judgment is required in choosing among alternate courses of action in following procedures; procedures obsolesce quickly due to the evolving nature of the on-line database, this position must adapt to and remember the current procedure but knowledge of past practices is useful in solving problems.
7. PERSONAL CONTACTS AND PURPOSE OF CONTACTS (Describe the normal types of contacts with persons other than those in the supervisory chain and the purpose of the contacts)
Frequent contact with branches is essential to gather information for problem-solving. Branches contact this position to resolve problems also. Position serves as an operational contact with all units of the Libraries throughout the campus. This position and the students whose work they revise are the visible presence of the Technical Services Division throughout the Libraries.
8. PHYSICAL DEMANDS/WORK ENVIRONMENT (Describe the nature of physical activity involved and any unusual environmental conditions)
The person must be able to travel among all library installations throughout the campus in all kinds of weather. The person must be able to withstand a variety of work station environments which will provide only limited space in most instances; and must be able to work with several types of CRT terminals. The work week may be scheduled over any of the hours of an extended clock week and is not necessarily limited to days Monday through Friday.

L. Lee R. Jones 11-21-83
SIGNATURE TYPED NAME AND TITLE OF PERSON AUTHORIZED TO ASSIGN DUTIES DATE

EMPLOYEE'S SIGNATURE DATE

POSITION DESCRIPTION FORM

B. DUTIES AND RESPONSIBILITIES (cont'd)

5. Charges on the on-line Geac circulation system material pulled from collections in order to provide patrons and staff with access to current status of material; discharges or indicates to branches the need to discharge material so that corrections to holdings data can be made
6. Updates the local ACC Bibliographic Subsystem; trains students in adding completed status to bibliographic entries whose cards have arrived; this status ensures that the record can be removed from the current datafile.
7. Acts as primary contact for branch libraries needing help with processed materials.
8. Records statistics for material whose locations or holdings changed in the course of corrections.
9. Performs other duties as required.

D. 1. Knowledge (cont'd).

knowledge of Geac tagging requirements for monographs.

2. Specific Skills (Cont'd)

understanding of automated data processing concepts; sound knowledge of file structure concepts.

5. COMPLEXITY OF DUTIES (cont'd)

The position also requires substantial interaction with procedures in other departments and libraries and an understanding of the structure of all catalogs on campus. Familiarity with the processes for ordering cards and correcting on-line records is essential. Changes in procedures occur frequently and this position must provide input for the changes.



VIRGINIA POLYTECHNIC INSTITUTE AND STATE UNIVERSITY

Blacksburg, Virginia 24061

UNIVERSITY LIBRARIES BIBLIOGRAPHIC SERVICES DEPARTMENT (703) 961-4609

JOB DESCRIPTION

Title: Assistant Bibliographic Services Librarian and
Head, Authority Control Division

Rank: Faculty

Division/Department: Authority Control Division/Bibliographic Services
Department

Qualifications: ALA accredited Master's degree in library science.
Experience in cataloging, supervision, and library
automation. Knowledge of at least one foreign lan-
guage desirable.

Job Summary:

The responsibilities of this position include the development, coordina-
tion and management of an efficient and cost-effective system of authority
control for the University Libraries manual catalogs and the VTLS database.
All aspects of precatalog searching to identify duplicates and authority
conflicts are handled in addition to some bibliographic records maintenance
including monographic adds, transfers, and withdrawals. The incumbent re-
ports to the Head of the Bibliographic Services Department.

Duties:

1. Organize the work of the Authority Control Division. The division is responsible for all online authority control utilizing the Library of Congress Name Authority File as found on OCLC for compatibility with VTLS; for editing and/or entering all authority records in VTLS from edited printouts or workforms; for manual authority control in the card catalog; for pre-catalog searching of access points for new materials for which authority work may be required; and for processing monographic adds, transfers and withdrawals.
2. Develop effective training programs and supervise and evaluate the work of three library assistants (2 FTE), 1 data entry operator, 2.5 clerical assistants and student assistants assigned to authority control activities.
3. Develop plans for integrating series and subject authority control into VTLS.
4. Evaluate and recommend enhancements to VTLS authority control subsystems, for more effective database management.

Job Description
Head, Authority Control Division

5. Develop and maintain effective working relationships with other units of the department generating catalog records.
6. Resolve problems encountered by staff involved in the various activities related to authority control.
7. Interface with Systems Department on all automation activities involving authority control.
8. Maintain a current awareness of national and international developments in library automation, cataloging, and related areas of bibliographic control.
9. Participate in weekly meeting of division supervisors and the department head and, in this group, assist in planning and organizing the work of the department and in establishing departmental policies and procedures.
10. Perform other duties as assigned by the department head.

JOB DESCRIPTION

Title: Assistant for Automated Authority Control

Rank/Class: Library Assistant (Position no. 1498)

Division/Department: Automated Cataloging Division
Bibliographic Services

Qualifications: College degree or four years experience or a combination equalling four years. Library experience and experience in working with computerized systems. Knowledge of one or more foreign languages helpful.

Duties:

1. Report to the head of the Automated Cataloging Division.
2. Search OCLC system for Library of Congress authority records. Prepare authority printouts and workforms for entry into Virginia Tech Library System (VTLS). Establish manual authority records for card catalog as necessary.
3. Assist the head of the Automated Cataloging Division in coordinating the daily flow of authority records through the division by revising the authority control operations performed by data entry operators and student assistants.
4. Assist in interpreting data, answering questions, and resolving problems for divisional personnel performing authority control functions.
5. Keep statistical and other managerial type records for authority control projects as requested by the supervisor.
6. Perform other duties as assigned by the division head or the department head.

JOB DESCRIPTION

Title: Assistant for Automated Authority Control

Rank/Class: Library Assistant (Position no. 0145)

Division/Department: Automated Cataloging Division / Bibliographic Services

Qualifications: College degree or four years experience or a combination equalling four years. Library experience and experience in working with computerized systems. Knowledge of one or more foreign languages helpful.

Duties:

1. Report to the head of the Automated Cataloging Division.
2. Search OCLC system for Library of Congress authority records. Prepare authority printouts and workforms for entry into Virginia Tech Library System (VTLIS). Establish manual authority records for card catalog as necessary.
3. Assist the head of the Automated Cataloging Division in coordinating the daily flow of authority records through the division by revising the authority control operations performed by data entry operators and student assistants.
4. Assist in interpreting data, answering questions, and resolving problems for divisional personnel performing authority control functions.
5. Assist in training new personnel in the division and in training student assistants. Maintain files and manuals for authority control training purposes and as working tools.
6. Keep statistical and other managerial type records for authority control projects as requested by the supervisor.
7. Perform other duties as assigned by the division head or the department head.

revised 10/84

BIBLIOGRAPHIC CONTROL DEPARTMENT
Department Head

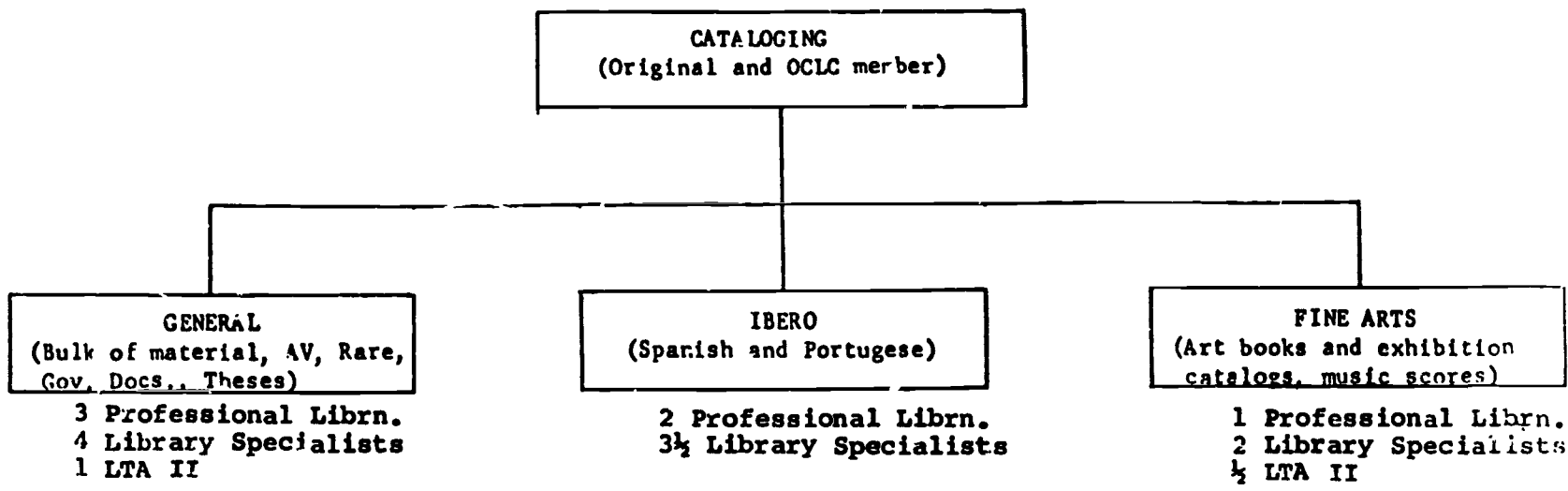

112

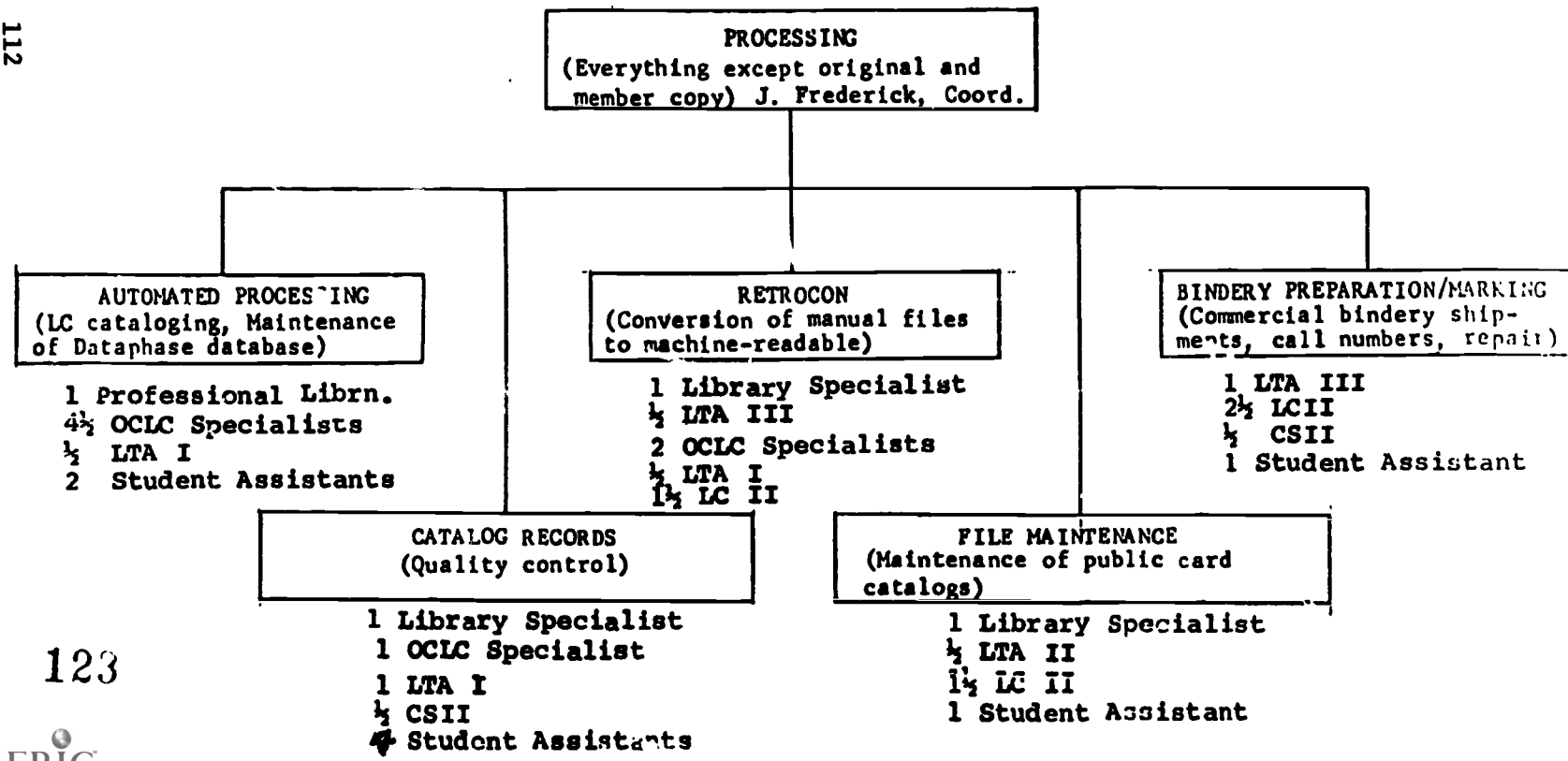

123

124

JOB TITLE: LIBRARY SPECIALIST JOB CODE: 59814
DEPARTMENT: GENERAL LIBRARY EXEMPT: X NON-EXEMPT: _____
APPROVED: Paul Rindenberg PERSONNEL J. Barnard DATE: 8-23-82

SUMMARY:

Under limited supervision and reporting to a Librarian is responsible for carrying out the most difficult, specialized and technical duties delegated by a librarian to other staff. Assumes responsibility for considerable supervisory and public relations work.

DUTIES AND RESPONSIBILITIES:

Typical duties and responsibilities include but are not limited to performing complicated bibliographic tasks; original cataloging; handling the most complex reference questions in area of expertise--both manually and in on-line systems; implementing and interpreting Library policies; overseeing departmental procedures; assisting in hiring, training, supervising and evaluating staff; assisting with complex record keeping, conducting special projects, coordinating intra-departmental activities and serving as liaison to other University departments; scheduling and providing library orientation and instruction; recommending operational changes; selecting materials for the collection.

Although the above are typical of the duties and responsibilities normally performed, additional duties and responsibilities requiring the same or lesser skills, knowledge and dexterity may be required.

EDUCATION AND EXPERIENCE:

Bachelors degree in appropriate field with three-five years of progressive and directly related experience required. Master's degree preferred. Equivalent education and experience will be accepted in lieu of the degree requirement.



THE UNIVERSITY OF NEW MEXICO

JOB TITLE: LIBRARY TECHNICAL ASSISTANT III JOB CODE: 68110
DEPARTMENT: GENERAL LIBRARY (TECHNICAL SERVICES) EXEMPT: NON-EXEMPT: X
APPROVED: Paul Kanells PERSONNEL: J.P. Barron DATE: 3-15-84

SUMMARY:

Under general supervision and reporting to a Librarian is responsible for planning, and supervising services for a section of a Library department. Actively participates with the department head to meet the complete service needs of the specified section. Will have considerable latitude for exercising independent action and judgement.

DUTIES AND RESPONSIBILITIES:

Typical duties and responsibilities include but are not limited to:

1. Supervising the work of a section in a department which requires planning, organizing and monitoring the work flow of the section.
2. Participating in hiring and terminating staff.
3. Hiring, terminating, scheduling, training, assigning tasks and evaluating student assistants.
4. Performing complex problem solving functions and serving as resource person within the section, department and library.
5. Interacting with national and international vendors, publishers, networks and bibliographic utilities to solve invoicing, acquisitions and a variety of bibliographic problems.
6. Creating and keeping current internal procedural manuals and documentation.
7. Selecting vendors for the purchase of library materials.
8. Completing and approving orders for data entry.

Although the above are typical of the duties and responsibilities normally performed, additional duties and responsibilities requiring the same or lesser skills, knowledge and dexterity may be required.

EDUCATION AND EXPERIENCE:

High school graduate or equivalent education with a minimum of five years of progressive or directly relevant experience required. Equivalent combination of education and experience will be accepted in lieu of the above. Must possess: knowledge of library procedures, general and highly specialized bibliographic tools, automated library systems, the ability to work independently, plan and

EDUCATION AND EXPERIENCE - Con't

initiate projects, exercise organizational and administrative skills and the ability to communicate effectively and harmoniously. Specialized subject knowledge may be required. Reading knowledge of one or more appropriate foreign languages may also be required.

JOB TITLE: LIBRARY TECHNICAL ASSISTANT II JOB CODE: 68108
DEPARTMENT GENERAL LIBRARY (TECHNICAL SERVICES) EXEMPT: NON-EXEMPT: X
APPROVED: *Steve Kennell* PERSONNEL: *J. J. Barnard* DATE: 3-14-84

SUMMARY:

Under general supervision and reporting to an LTA III or above is responsible for performing para-professional assignments requiring sound judgement, ability to work independently and knowledge of specialized as well as general library operations and procedures.

DUTIES AND RESPONSIBILITIES:

Typical duties and responsibilities include but are not limited to:

1. Editing member contributed O90 bibliographic records on the OCLC system using detailed and specific knowledge of international cataloging rules, procedures and the MARC tagging format.
2. Assigning call numbers for works of fiction in many languages and for later editions of works previously cataloged.
3. Verifying and establishing name and series authority records for OCLC, DataPhase and the Public Card Catalogs.
4. Preparing descriptive cataloging copy using international cataloging rules and MARC tagging format.
5. Revising card catalog filing, and resolves problems encountered. Recommends cross-references (using ALA filing rules).
6. Answering reference questions.
7. Supervising and coordinating work of staff and student employees, participating in hiring and evaluation of staff and students, monitoring workflow and preparing statistical reports, etc.
8. Performing high level maintenance of local bibliographic records, including reclassification, withdrawals, reinstating and inventory.
9. Preparing material for shipment to the commercial book bindery and to University Microfilms including liaison work, record preparation, communication and coordination with the Graduate School and the Library collection development coordinators. Verifies bindery invoices, compiles statistics and responsible for special services such as repair of books.

LIBRARY TECHNICAL ASSISTANT II
GENERAL LIBRARY (TECHNICAL SERVICES)

JOB CODE: 68108

Although the above are typical of the duties and responsibilities normally performed, additional duties and responsibilities requiring the same or lesser skills, knowledge and dexterity may be required.

EDUCATION AND EXPERIENCE:

High school graduate or equivalent education with a minimum of four years of progressive and directly relevant experience required. Equivalent combination of education and experience will be accepted in lieu of the above. Must possess: knowledge of library procedures, general bibliographic and specialized tools, the ability to handle complex assignments, organizational and administrative abilities and sufficient typing skills in order to operate microcomputers and terminals. Reading knowledge of at least one appropriate foreign language and knowledge of OCLC or other automated cataloging system required. Specialized subject knowledge may be required.

JOB TITLE: OCLC SPECIALIST JOB CODE: 71808
DEPARTMENT: GENERAL LIBRARY EXEMPT: NON-EXEMPT:
APPROVED: *Philip L. Migneault* PERSONNEL: *J. B. Barnard* DATE: 4-01-85

SUMMARY:

Under general supervision and reporting to an LTA III or above is responsible for performing assignments requiring sound judgment, ability to work independently and knowledge of specialized as well as general library operations and procedures.

DUTIES AND RESPONSIBILITIES:

Typical duties and responsibilities include but are not limited to:

1. Searching OCLC for cataloging.
2. Revising and editing records.
3. Updating library holdings.
4. Inputting new records into OCLC.
5. Revising new inputs tagged and entered into OCLC by lower level employees.

Although the above are typical of the duties and responsibilities normally performed, additional duties and responsibilities requiring the same or lesser skills, knowledge and dexterity may be required.

EDUCATION AND EXPERIENCE:

High School graduate or equivalent education with a minimum of four years of progressive and directly relevant experience required. Must possess knowledge of general bibliographic tools, library procedures, automated library systems and good communication skills. OCLC experience required. Knowledge of cataloging practices useful.

THE UNIVERSITY OF NEW MEXICO

JOB TITLE: LIBRARY TECHNICAL ASSISTANT I JOB CODE: 68106
DEPARTMENT: GENERAL LIBRARY (TECHNICAL SERVICES) EXEMPT: NON-EXEMPT X
APPROVED: Paul Konallo PERSONNEL: J. L. Brunard DATE: 3-14-84

SUMMARY:

Under general supervision and reporting to an LTA II, LTA III, or other designated supervisor is responsible for performing a wide variety of assignments generally in a specific section of the Library requiring sound judgement, ability to work independently and a thorough knowledge of Library procedures.

DUTIES AND RESPONSIBILITIES:

Typical duties and responsibilities include but are not limited to:

1. Using various library files and tools (including OCLC, DataPhase, NUC Catalogue, foreign Books in Prints, etc.), searches for suplicates, verification of bibliographic data and information and availability of materials. Must be able to select appropriate records.
2. Reviewing, editing, updating and maintaining accuracy of computer-produced files.
3. Editing CIP records and producing cards for public card catalog.
4. Training students on item conversion and revising work as necessary.
5. Coordinating and monitoring work of assigned employees.
6. Participating in hiring and supervising students.
7. As directed will supervise employees.
8. Verifying orders on BATAB produced by others.
9. Coordinating the receipts and delivery of Computer Center reports, schedules, and other documents as needed.
10. Initiating and receiving telephone, walk-in and other forms of donor contacts. Responsible for follow-ups.
11. Collecting and collating statistical data for monthly reports on productivity and volume.

Although the above are typical of the duties and responsibilities normally performed, additional duties and responsibilities requiring the same or lesser skills, knowledge and dexterity may be required.

LIBRARY TECHNICAL ASSISTANT I
GENERAL LIBRARY (TECHNICAL SERVICES)

JOB CODE: 68106

EDUCATION AND EXPERIENCE:

High school graduate or equivalent education with a minimum of two years of progressive and directly relevant experience required. Equivalent combination of education and experience will be accepted in lieu of the above. Must possess knowledge of general bibliographic tools, library procedures as appropriate to specific assignment and good communication skills. Reading knowledge of at least one appropriate foreign language highly desirable and may be required.

REPRODUCTION OF ORIGINAL

JOB TITLE: LIBRARY CLERK JOB CODE: 24661
DEPARTMENT: GENERAL LIBRARY EXEMPT: NON-EXEMPT Y
APPROVED: Robert L. McQuinn PERSONNEL: John B. ... DATE: 3-07-88

SUMMARY:

Under direct supervision, a Library Clerk will perform a variety of duties of moderately complex nature involving the practice of specialized procedures in direct support to academic library operations. As directed, will train and supervise lower classified library staff and student assistants.

DUTIES AND RESPONSIBILITIES:

Typical duties and responsibilities include but are not limited to performing card records keeping, revising and filing of shelf lists, performing acquisition duties involving the receipt and processing of books in the English language, performing checks on monographs and serials for holding and verification of trade or bibliographic information using the necessary bibliographic references, assisting in the processing and inputting of reserve materials, charging and discharging of reserve materials, overseeing the recall operation, pricing lost books and computing fines on overdue materials, overseeing stacks and reading area maintenance, use the OCLC system to send interlibrary loan requests, prints and maintains "Message Waiting" file.

Although the above are typical of the duties and responsibilities normally performed, additional duties and responsibilities requiring the same or lesser skills, knowledge and dexterity may be required.

EDUCATION AND EXPERIENCE:

High School graduate or equivalent required with a minimum of one year library experience or equivalent required. Typing skills, accuracy more than speed, knowledge of library procedures, and the ability to work independently desired.

BEST COPY AVAILABLE

Bibliography

1. Judith Hudson, "Bibliographic Record Maintenance in the Online Environment," Information Technology and Libraries, 3(4), December 1984, p. 338-393.
2. Dennis Reynolds, Library Automation: Issues and Applications (New York : R.R. Bowker Company, 1985).
3. David C. Genaway, Integrated Online Library Systems: Principles, Planning and Implementation (White Plains, N.Y. : Knowledge Industry Publications, Inc., 1984).
4. Association of Research Libraries. Systems and Procedures Exchange Center, Automation and Reorganization of Technical and Public Services (Washington, D.C. : Systems and Procedures Exchange Center, 1985). (SPEC kit no.112).
5. Suzanne Striedieck, "Online Catalog Maintenance--the OOPS Command in LIAS", Cataloging and Classification Quarterly, v.6 1985/86.
6. Joe Busch et al, "Coming Out of the Back Room: Management Issues for Technical Services in the Eighties", Technical Services Quarterly, v.2, nos.3/4, Spring/Summer 1985, pp. 115-141.
7. Louise Garraux Glogoff et al, "Computer-Based Training Program for Cataloging Department Staff", Journal of Academic Librarianship, v.10, no.1, p. 23-28, 1984.
8. James G. Neal, "And the Walls Came Tumblin' Down: Distributed Cataloging and the Public/Technical Services Relationship - the Public Services Perspective", Proceedings of the 47th ASIS Annual Meeting, v.21, 1984, pp. 114-120.
9. Janet Swan Hill, "Northwestern University Library and Day One: A Catalog Maintenance Smorgasbord," (unpublished paper).
10. Jaye Bausser, "Online Catalogs: Issues and Concerns," ED 253 251.

BE AVAILABLE